



# AC 伺 服 馬 達 AC SERVO MOTOR

## 使 用 說 明 書 USER MANUAL

**MODEL : HVP-70 SERIES**

MINI-MOTOR TYPE

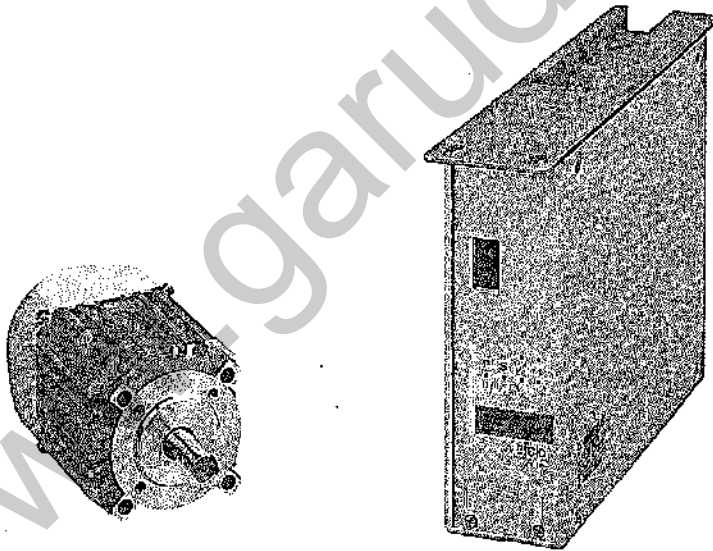

中 國 語

English

Please read this manual thoroughly before use to ensure safe and proper use.  
Please read the instruction manual for the machine head together with this manual.  
Save this manual for future reference.

EEM70U01-2

2007.10

# Model : HVP - 70 Series

## Contents

	Page
<b>1. Safety Precaution</b>	
1.1 Work environment .....	1
1.2 Safety in installation .....	1
1.3 Safety in operating .....	2
1.4 Safety in maintenance and repairs .....	2
1.5 Regulation in maintenance and repairs .....	2
1.6 Danger and caution signs .....	2
1.7 Warranty information .....	2
<b>2. Installation and Adjustment</b>	
(1). Motor installation .....	3
(2). Control box installation .....	3
(3). Speed control unit installation .....	3
(4). Components of belt cover adjustment .....	4
(5). Install the belt cover .....	4
(6). Install and adjust the synchronizer .....	5
(7). Speed control unit adjustment .....	5
<b>3. Power Connection and Grounding</b>	
(1). Single phase and three phase connection .....	6
(2). How to connect a 1 $\phi$ / 220 V power from a 3 $\phi$ / 380 V power source .....	6
(3). The load balance when use 1 $\phi$ / 220 V motors used on a 3 $\phi$ / 220 V power source .....	7
(4). How to change solenoid supply voltage (DC 24 V or 30 V) .....	7
(5). How to supply a AC power source extend from the control box .....	8
<b>4. Diagrams of Control Box</b>	
(1). Front side of the control box .....	9
(2). Rear side of the control box .....	9
<b>5. Programmable 7-segment Display</b>	
(1). How to access the [Normal Mode] .....	10
(2). Key functions in the [Normal Mode] for a lockstitch machine .....	10
(3). Key functions in the [Normal Mode] for a interlock machine .....	11
(4). How to perform 『BAR Tacking』 and 『Constant-Stitch Sewing』 in the [Normal Mode] .....	11
(5). How to access [Parameter Mode A] .....	12
(6). How to access [Parameter Mode B] .....	12
(7). Key functions in the [Parameter Mode A and B] .....	13
(8). How to adjust the parameter setting .....	13
(9). Setting values for A、B、C、D keys .....	14

	Page
<b>6.General Parameter Table</b> .....	15
<b>7.Basic Troubleshooting</b>	
(1). Error Code and Measurement .....	16
(2). Instruction of Fuse Replacement .....	17
(3). Others .....	17
(4). HVP-70 Parts List .....	18
<b>8.Operation Box</b> .....	19
<b>9.Basic diagrams of connector panel</b>	
(1). HVP-70-3/4-BR (T1) .....	21
(2). HVP-70-3/4-7W .....	22
(3). HVP-70-3/4-H1 (H1 / H2) .....	23
(4). HVP-70-4-66 (V7) .....	24
(5). HVP-70-4-46 (T2) .....	25
(6). HVP-70-4-70 .....	26
(7). HVP-70-4-98 .....	27
(8). HVP-70-4-GD .....	28

Bottom page:7-Segment Display Characters Compare Table

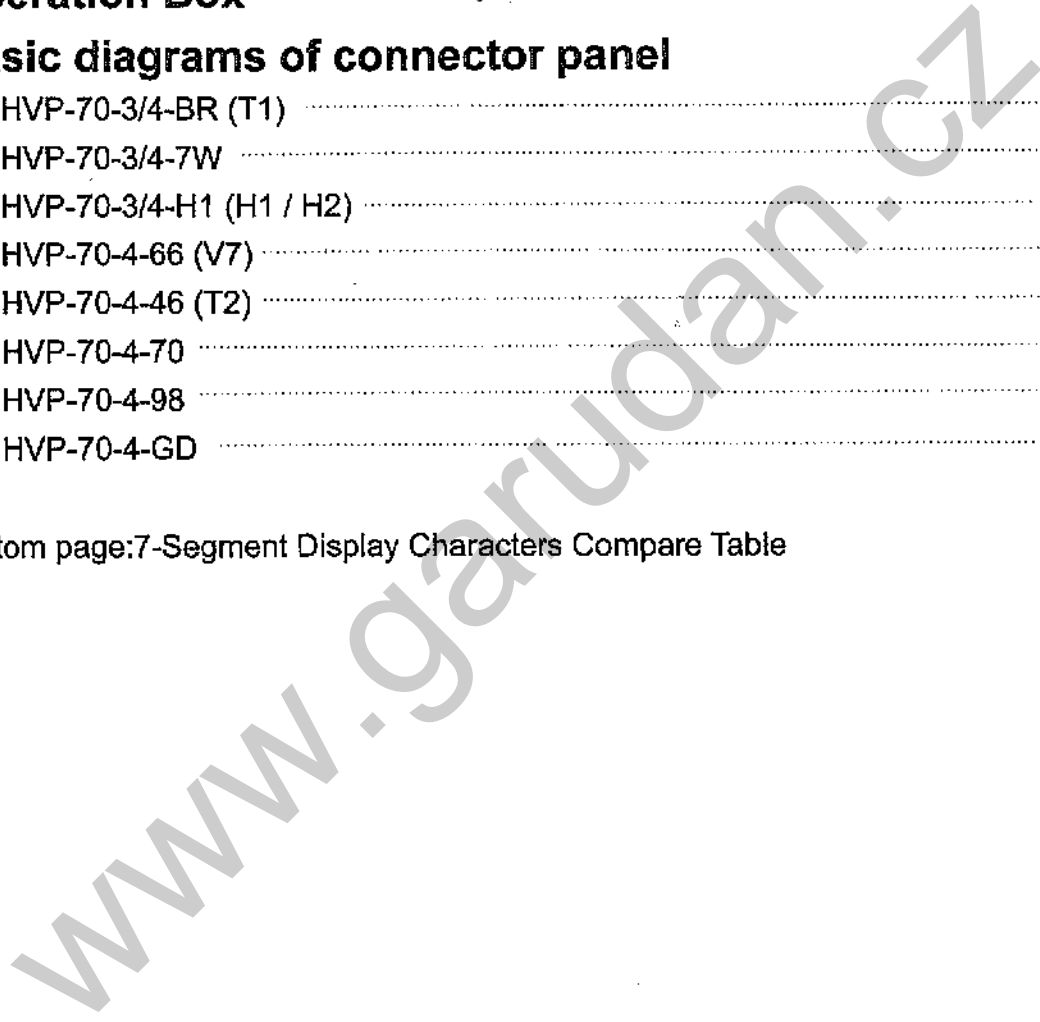

# 1. Safety Precaution :

**Please read this manual carefully , also with related manual for the machine head before use. For perfect operation and safety, installing and operating this product by trained personnel is required.**

When install and operate HVP-70 MINI Servo Motor, precaution must be taken as the following. This product is designed for specify sewing machines and must nbt be used for other purposes.

## 1.1 Work Environment :

### (1). Power voltage:

Only use Power Voltage indicated on the name plate of the HVP-70 in  $\pm 10\%$  ranges.

### (2). Electromagnetic pulse interference:

To avoid the false operate, please keep the product away from the high electromagnetic machinery or electro pulse generator.



### (3). Temperature:

- Please don't operate in room temperature is above  $45^{\circ}\text{C}$  or under  $5^{\circ}\text{C}$
- Avoid operating in direct sun light or outdoors area.
- Avoid operating near the heater.
- Avoid operating in the area which humidity is  $30\%$  or less and  $95\%$  or more, also keep away from dew area.

### (4). Atmosphere:

- Avoid operating in dusty area, and stay away from corrosive material.
- Avoid operating in evaporate or combustible gas area.

## 1.2 Safety In Installation :

- Motor and control box: Follow the Instruction in this manual for correct installation.
- Accessories: Turn off the power and unplug the cord before mounting any accessories.
- Power cord:
  - Avoid power cord being applied by heavy objects or excessive force, or over bend.
  - Power cord must not set to be near the V-belt and the pulley, keep 3 cm space or above.
  - Check the outlet voltage before plugging the cord, make sure it match the voitage shown on the name plate of the HVP-70 in  $\pm 10\%$  ranges.

**※ Attention : If the control box is AC 220V system, please don't connect to the AC 380V power outlet, otherwise the error code `E-0. 4` will occur. If that happened, please turn off the power switch immediately and check the power voltage. Continue supply the 380V power over 5 minutes might damage the fuses (F3,F4) and burst the electrolytic capacitors (C7,C8,C9) of the main board and even might endanger the person safety.**



(4). Grounding:

a. To avoid the static interference and current leakage, all grounding must be done

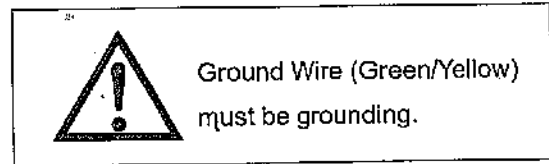
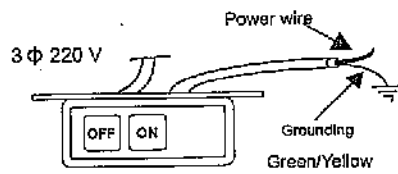

b. Use the correct connector and extension wire when connecting ground wire to Earth and secure it tightly.

**1.3 Safety In Operating :**

- (1). When turn on the machine in the first time, use low speed to operate and check the correct rotation direction.
- (2). During machine operation, don't touch any moving parts.
- (3). All moving parts must use the protective device to avoid the body contact and objects insertion.

**1.4 Safety in Maintenance and Repairs :**

Power must be turned off first, when:

- (1).Uninstall the motor or the control box, or plug and unplug any connector.
- (2).Turn off the power and wait 10 minutes before opening box cover.

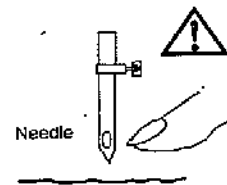
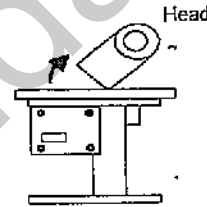
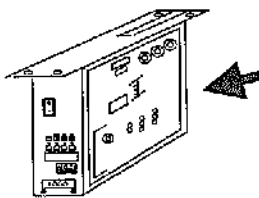

- (3).Raising the machine arms or changing needle, or threading needle.(show as above)
- (4).Repairing or doing any mechanical adjustment.
- (5).Machines rest.

**1.5 Regulation in Maintenance and Repairs :**

- (1).Maintenance and Repairs must be done by specially trained personnel.
- (2).Don't cover up motor's ventilation, it can cause motor over heated.
- (3).Don't use any objects or force to hit or ram the product.
- (4).All spare parts for repair must be approved or supplied by the manufacturer.

**1.6 Danger and Caution Signs :**



Risks that may cause personal injury or risk to the machine are marked with this symbol in the instruction manual.



This symbol indicates electrical risks and warnings.

**1.7 Warranty Information :**

Manufacturer provide a warranty in respect of the products covered for a period of 18 months after the shipping date of the products for any defects arising in the normal course of use of the products by customers.

## 2. Installation and Adjustment:

### (1). Motor installation:

- A). When motor and machine installed together, refer to the machine head's instruction.  
 B). When motor installed under the working table, drill holes in the table as the following diagrams for the installation.

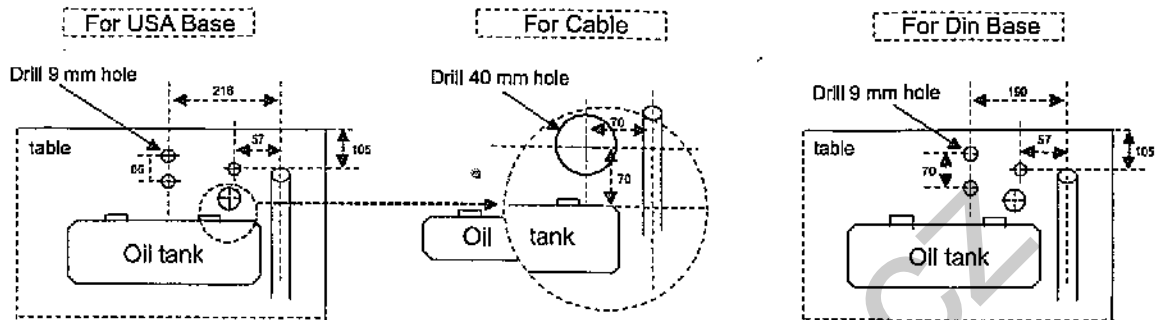

- (1) Pulleys of motor and machine must properly align.
- (2) Cable pass through under the working table must be secured to avoid the V-belt to be rubbed.
- (3) Use the motor base arm to adjust belt's tensions.

### (2). Control Box Installation:

- (a) Leave 100 mm space at right. (b) Mounting HVP-70 under the working table. (c) Installation layout.

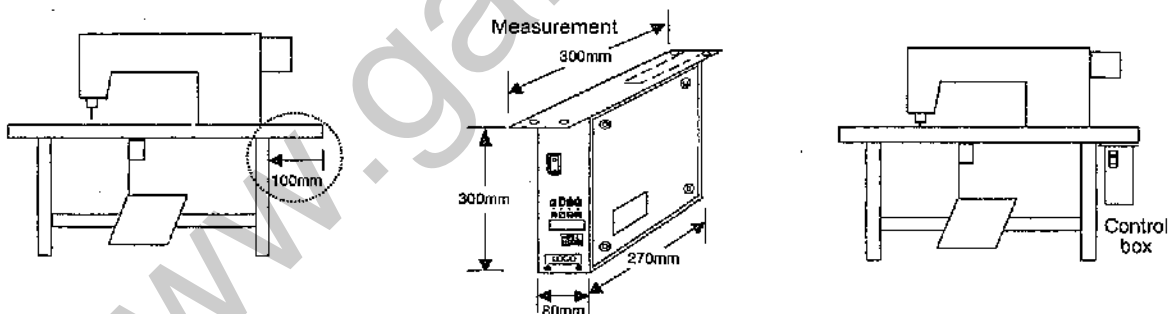

### (3). Speed Control Unit Installation:

- (a) Speed Control Unit (b) Keep rod in vertical, secure the unit under the table. (c) Installation layout.

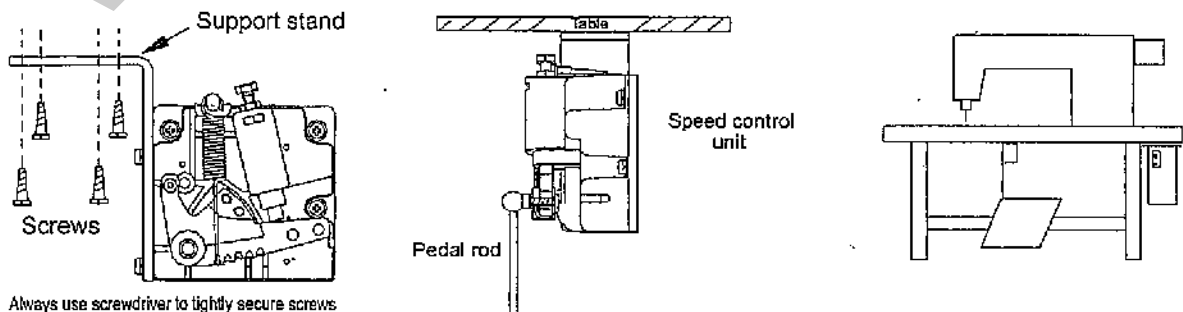

#### (4). Components of Belt Cover Adjustment:

##### A. Finger Guard Adjustment : (for CE type only)

- (1) Factory default: Finger guard is set at (B). (for lockstitch machine rotation direction).
- (2) When use Interlock stitch machine, Finger guard is set at (C).

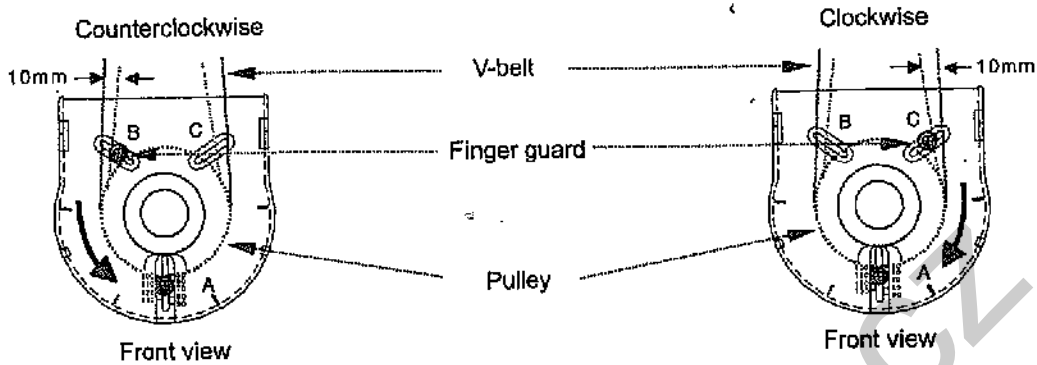

##### B. Belt Stopper adjustment :

- (a) Factory default: Belt stopper is mount at pulley scale about 100 mm's position (Fig. A) if pulley size change, follow the Fig. B.
- (b) Adjustment tips: Move stopper pointer aligned with any position at pulley diameter scale that matches the pulley diameter size.

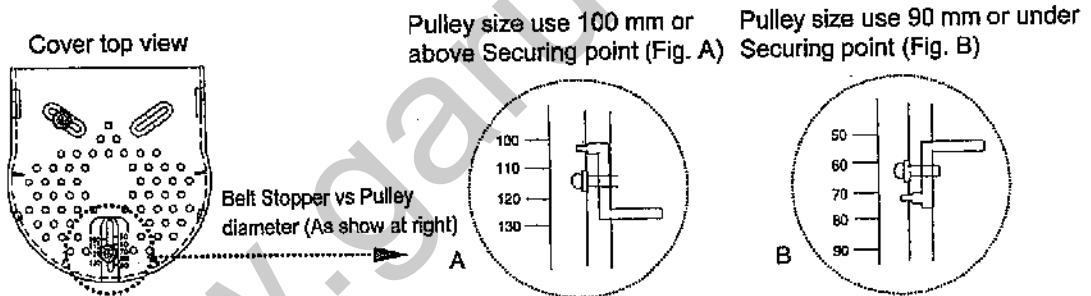

#### (5). Install The Belt Cover:

- (a) Install the belt cover at motor front cover. (screw hole face motor)

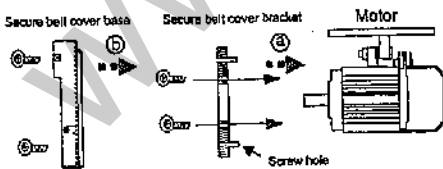

- (b) Then secure base to the belt cover bracket, let the opening face machine pulley.

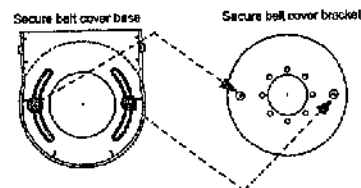

- (c) After base is installed, mount the motor pulley and secure it.

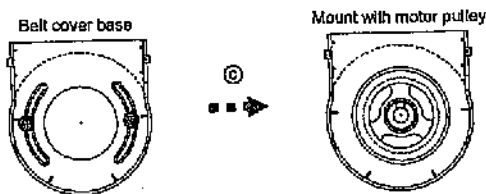

- (d) Finally put the belt cover and secure screw A,B

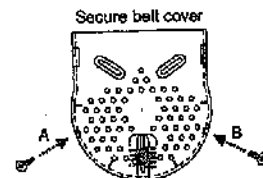

## (6). Install and Adjust the Synchronizer (sensor):

- a). Synchronizer installation: Mounting the Synchronizer onto the flange of machine pulley and fasten the rotor by setting screws.
- b). Synchronizer adjustment: Before adjustment, unscrew the synchronizer's cover screw, and remove the cover.



**Caution:**  
Turn OFF the power, before making the adjustment.

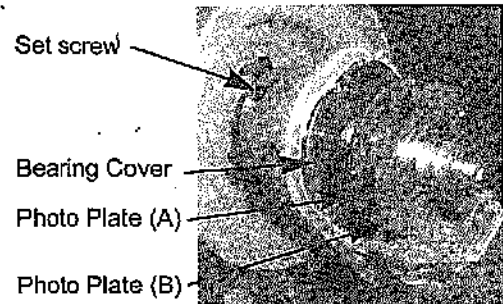

**Needle up position :** Rotate the machine pulley to reach mechanical needle up position and turn the photo plate (A) until its red mark is aligned with the red mark on the bearing cover plate.

**Needle down position :** Rotate the machine pulley to reach mechanical needle down position and turn the photo plate (B) until its blue mark is aligned with the red mark on the bearing cover plate.

**Note :** instruction above is the standard adjustment. If you feel the position wasn't accurate, please do the fine tuning by yourself.

## (7). Speed Control Unit Adjustment

Part for the speed control unit: see figure at right.

(A) Spring.

(B) Bolt.

(C) Treadle / Pedal arm.

(D) Pitman Rod for Treadle / Pedal.

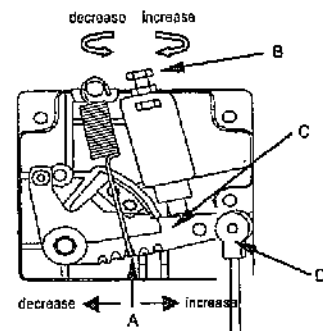

Term of adjustment		After adjustment
1	Toeing forward force adjustment	Spring A move to right = force increased Spring A move to left = force decreased
2	Heeling backward force adjustment	Bolt B turn $\curvearrowright$ = force decreased Bolt B turn $\curvearrowleft$ = force increased
3	Treadle stroke adjustment	Rod D secure at right = stroke is longer Rod D secure at left = stroke is shorter



### 3. Power Connection and Grounding:

#### (1).Single phase and three phase connection:

Green/yellow wire is the ground wire.

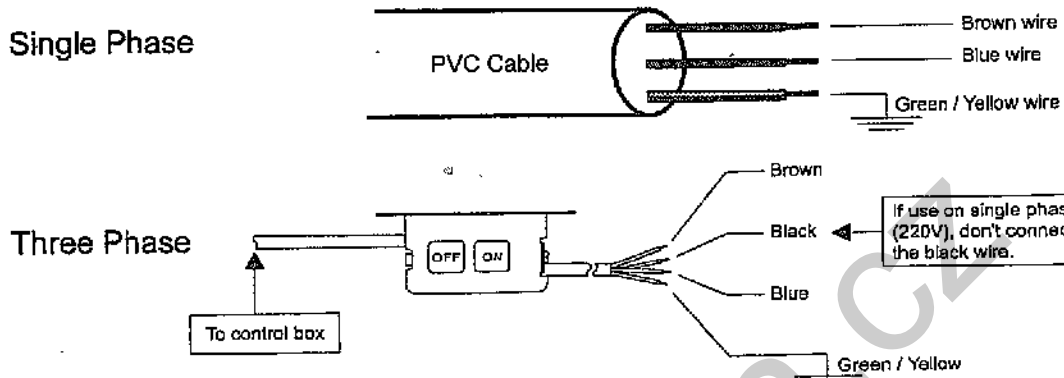

1. When a three phase 220V servo motor used on single phase 200~240V power, only connect brown and blue wires. Use insulating tape to wrap up the black wire, in order to prevent the current leakage.
  2. Green / Yellow wire must do the grounding.

#### (2).How to connect a 1 $\phi$ / 220 V power from a 3 $\phi$ / 380 V power source

Caution: If the system have no Neutral point, then this servo motor is not suitable for this connection.

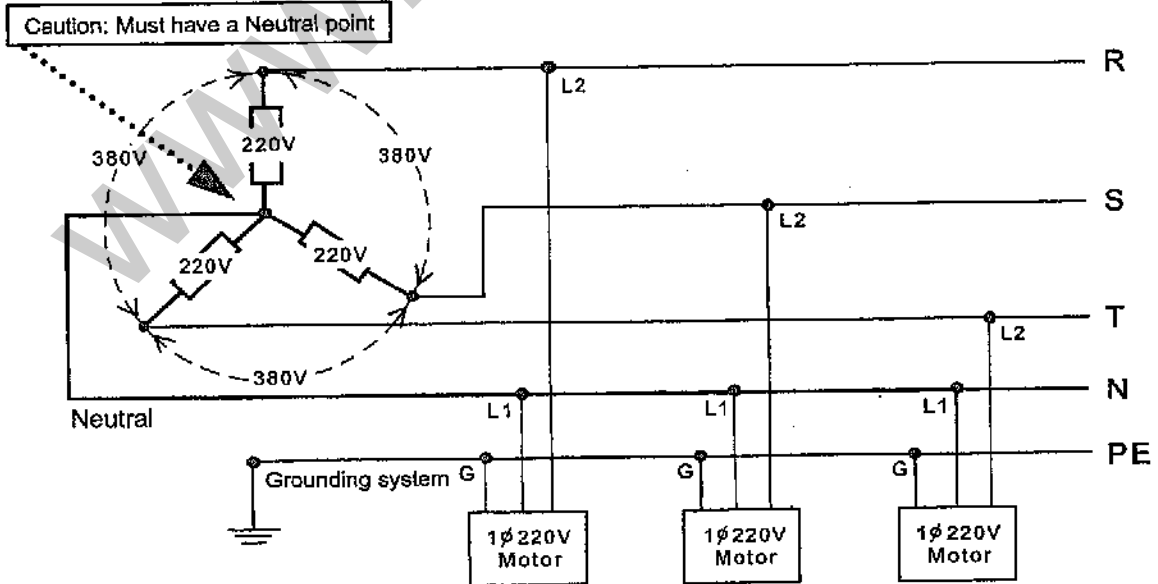

**(3).The load balance when use 1  $\phi$  / 220 V motors used on a 3  $\phi$  / 220 V power source.**

See the following figure for the load balance.

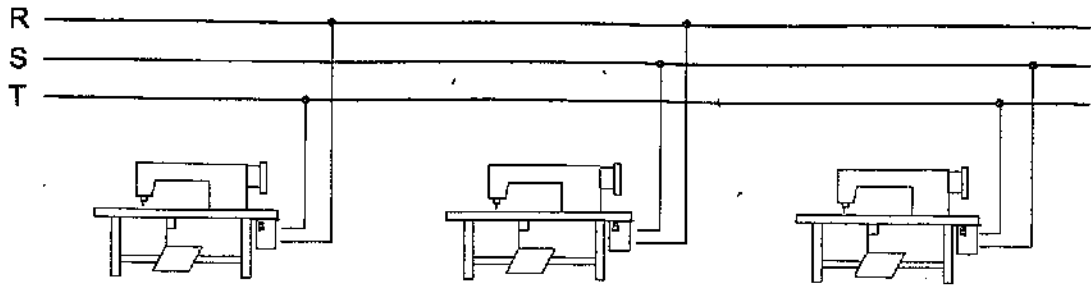

**(4).How to change solenoid supply voltage (DC: 24 V OR 30 V)**

The JP4 is for 30 V and JP5 is for 24 V.



Caution: Before change the setting, check the machine head's Solenoid specification.



Caution: Turn off the power wait for 10 min. before open the cover, then make the change.

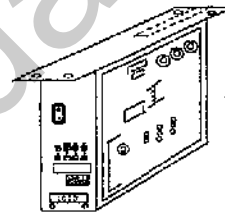

High Voltage Inside

Step 1

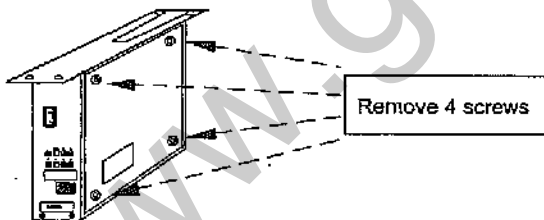

Main board layout:

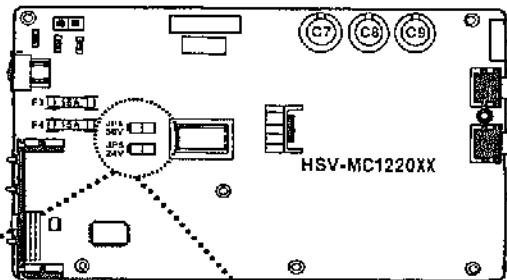

Step 2

30V jumper setting

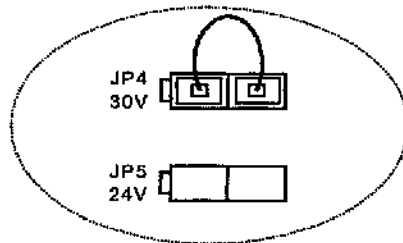

24V jumper setting

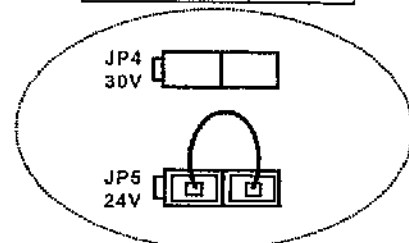

## (5).How to supply a power source extend from the control box:



**Caution 1:**  
Turn off the power wait for 10 min. before open the cover, then make the change.



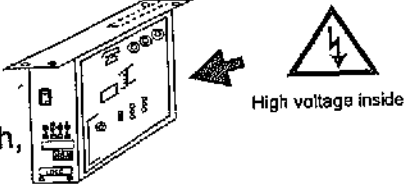

**Caution 2:**  
When turn off the control box's power switch, it will not turn off the extended power. Please add switch for the extended power.

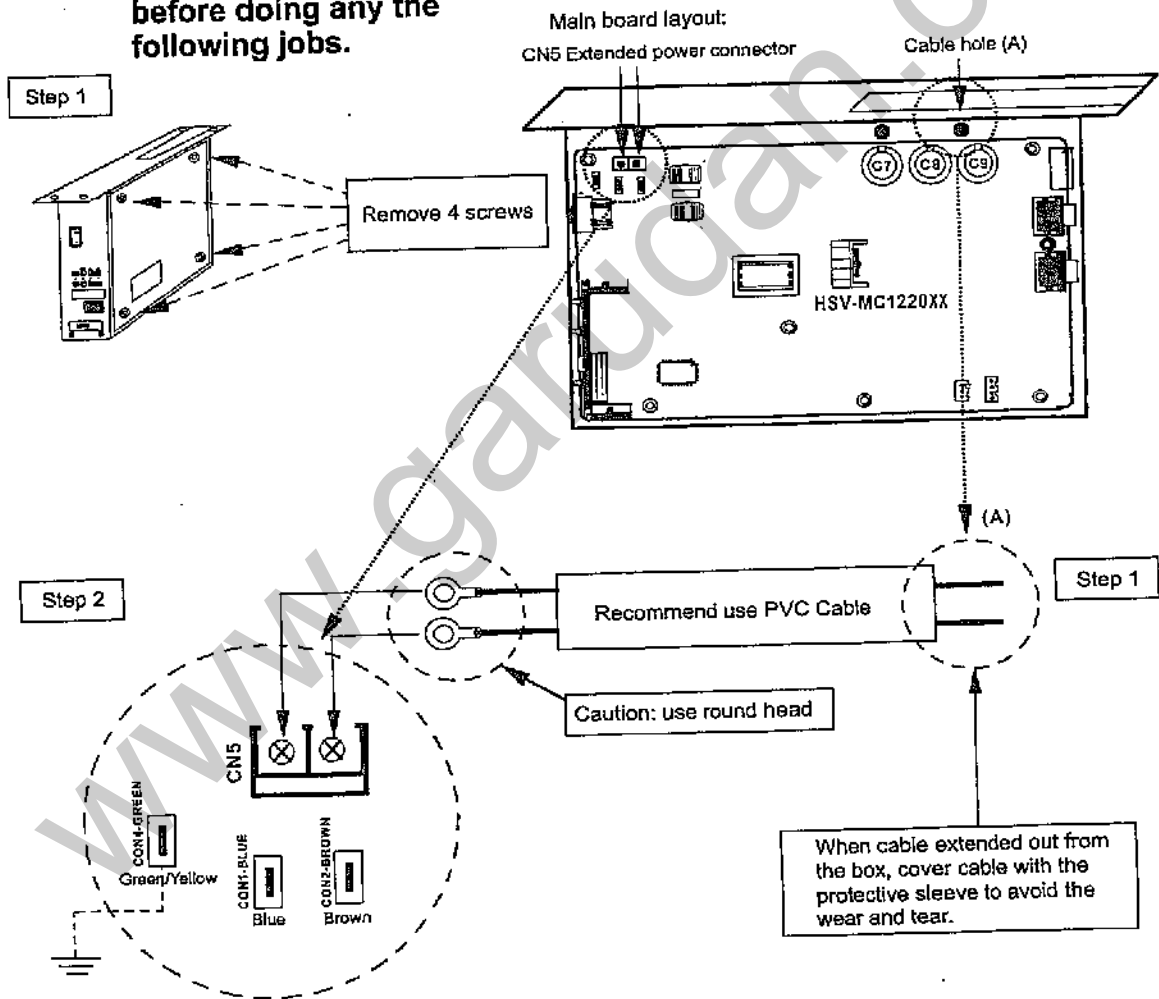

High voltage inside

**Caution: Unplug power cord before doing any the following jobs.**





**Caution :** 1. Use round head and secure tightly on CN5, can avoid electric noise and spark which caused by the bad connection.  
 2. After tighten the round head, let other side of the cable pass through the hole (A) and secure it.

### 4. Diagrams Of Control Box:

#### (1). Front side:

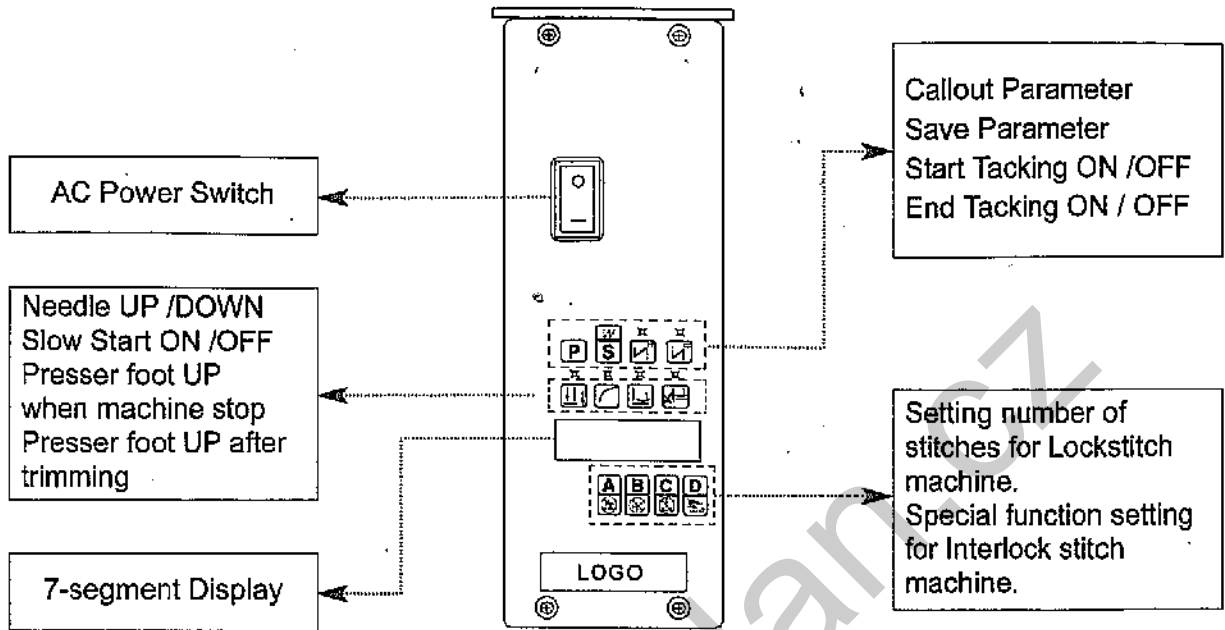

#### (2). Rear side: Connector Panel (Model sample: HVP-70-4-66)

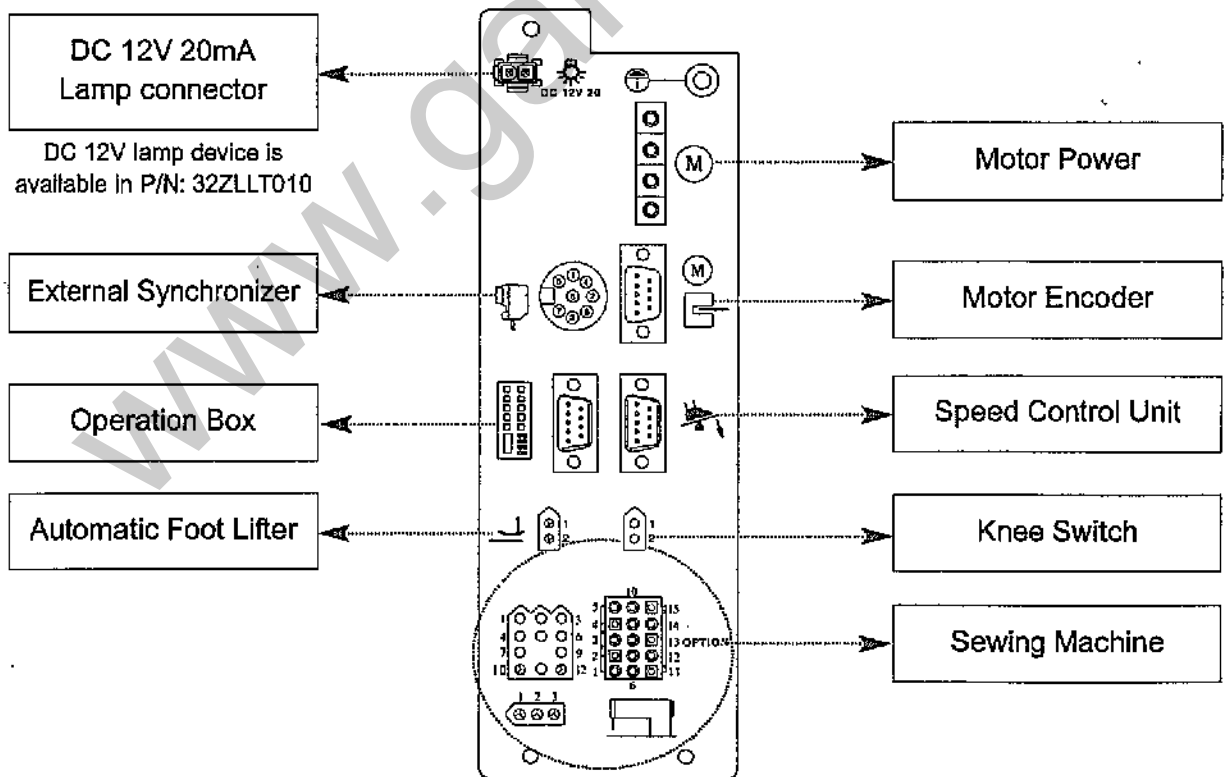

## 5. Programmable 7-segment Display:

### (1). How to access the [Normal Mode] area:

Turn on the power and you can access the [Normal Mode] right away.

※ Under this mode, there are Lockstitch and Interlock stitch type display different.

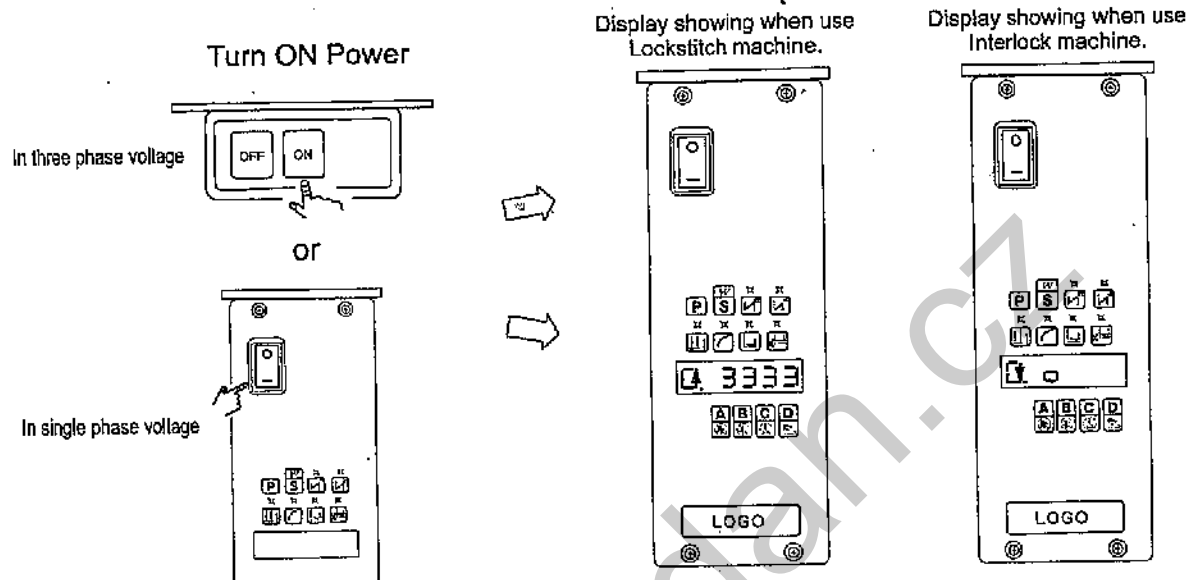

### (2). Key functions in the [Normal Mode] on a lockstitch machine

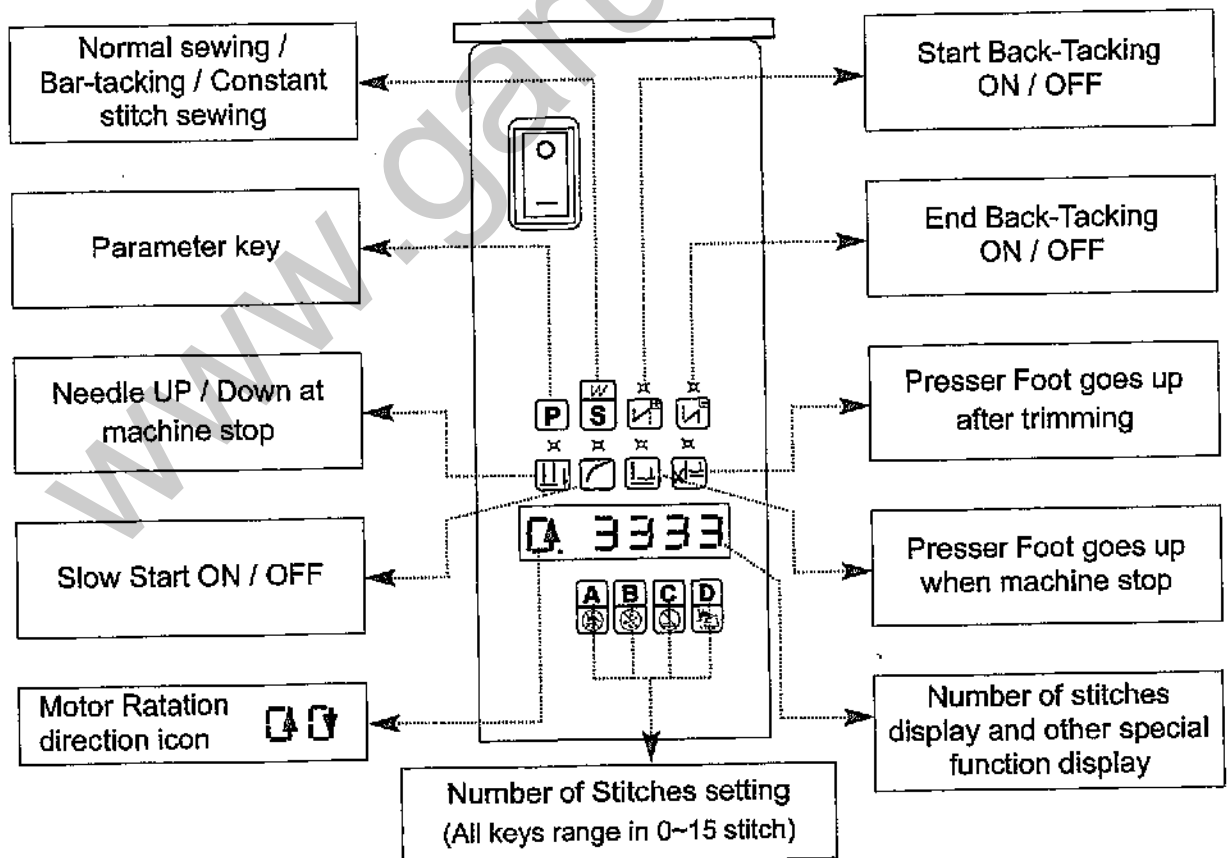

### (3). Key functions in the [Normal Mode] on a interlock stitch machine

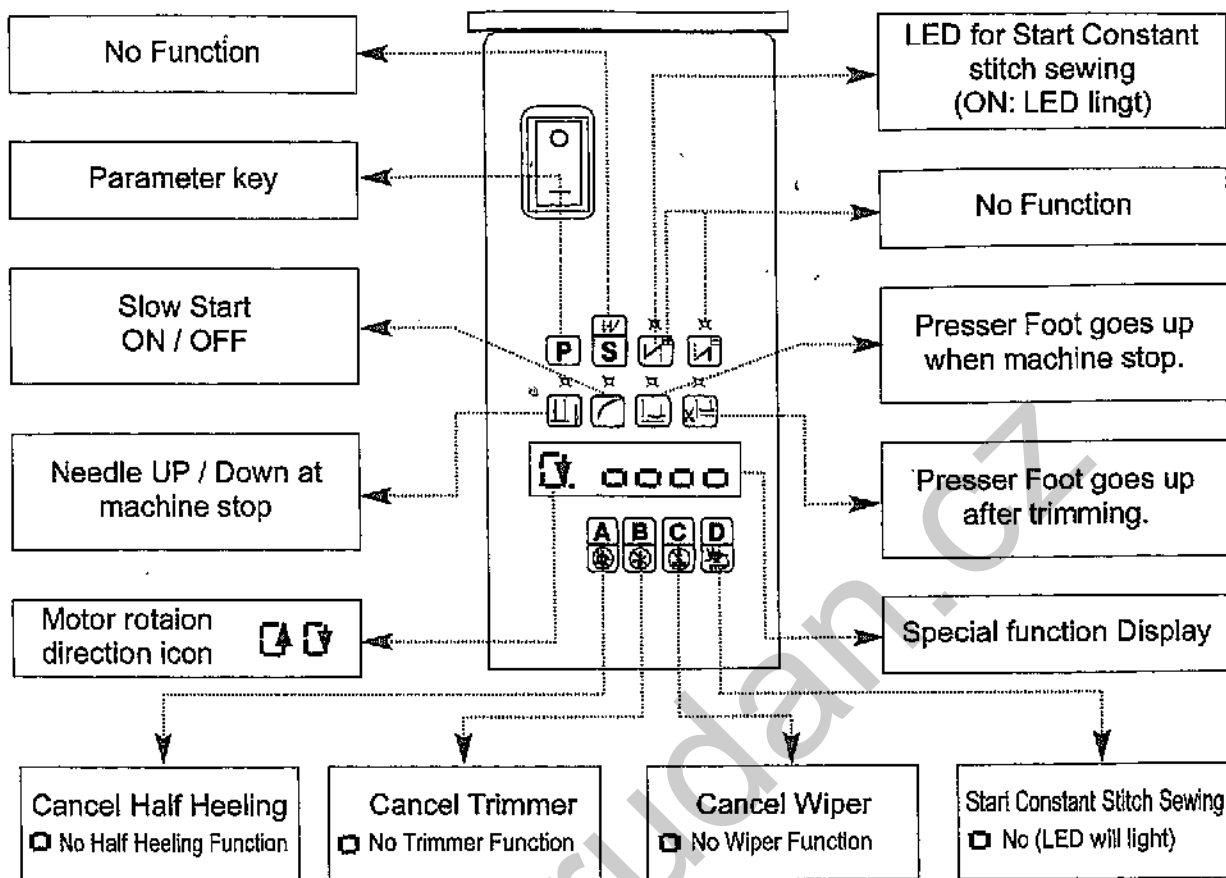

### (4). How to perform [BAR Tacking] and [Constant Stitch Sewing] in the [Normal Mode]

Under [Normal Mode], press key [S] can active and switch back and forth in normal sewing, Bar-tacking, and constant stitch sewing functions.

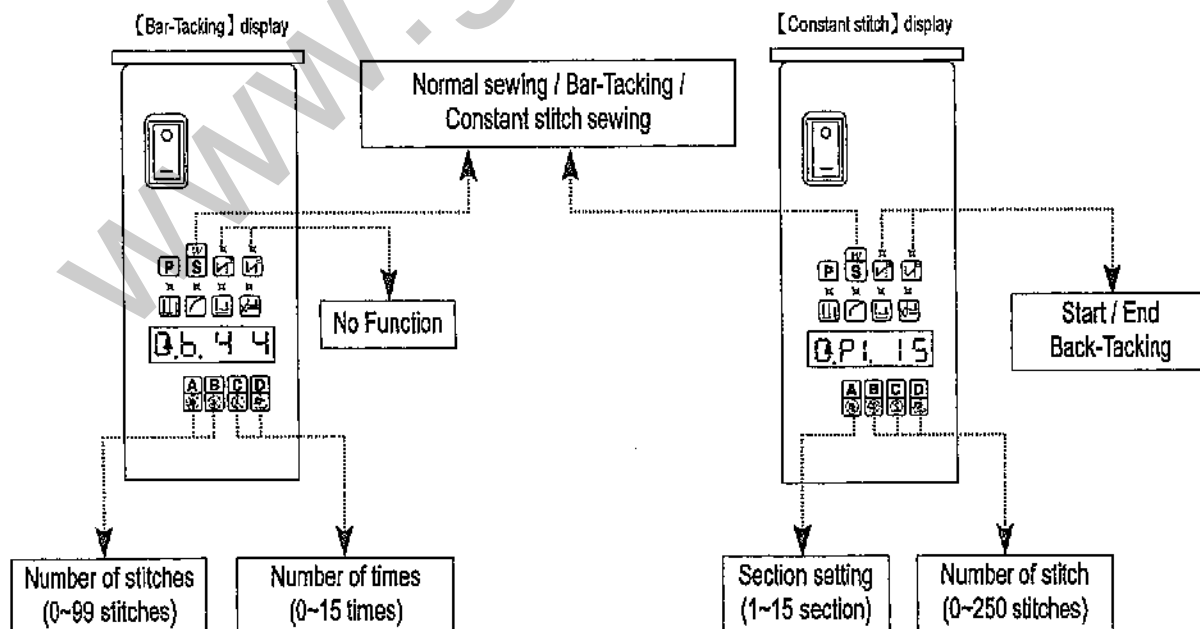

**(5).How to access [Parameter Mode A] :** (Available parameter codes : 1 ~ 46)

- a. Under [Normal mode] press key **[P]** will take you into the first parameter code [001.H] of [parameter mode A]
- b. Press **[P]** or **[M]** to get the parameter needed. e.g.: [002.PSL]
- c. Press **[S]** to enter [parameter value]
- d. In this area, press **[A][B][C][D]** key to make value adjustment.
- e. Press **[S]** key to save the value.

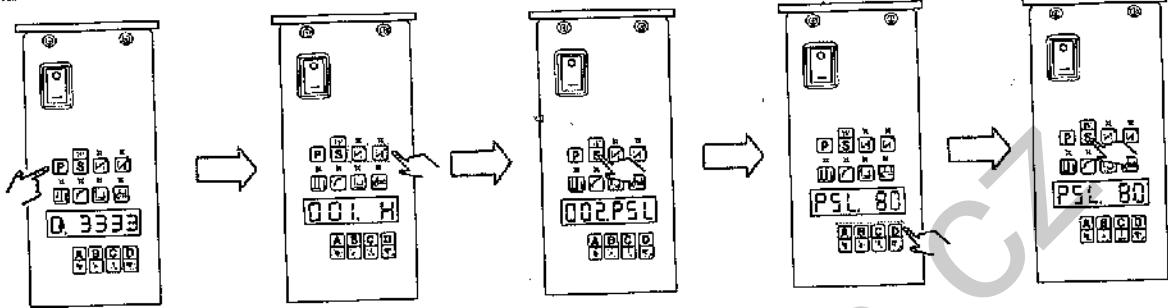

**(6).How to access [Parameter Mode B] :** (Available parameter codes : 1 ~ 122)

- a. Turn off the power
- b. Press and hold **[P]** key then turn on the power to access the first parameter code [047.MAC] of [parameter mode B]

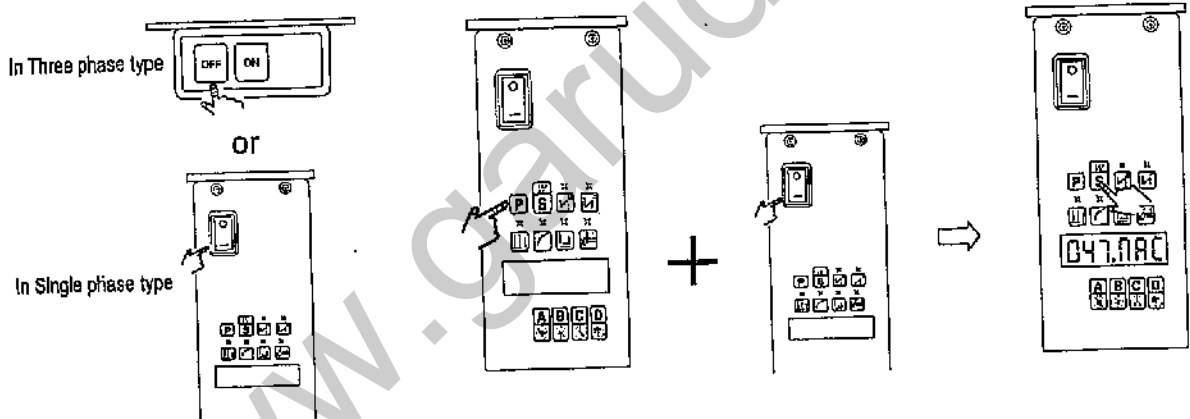

- c. Press **[P]** or **[M]** key to get the parameter code [048.N12]
  - d. Use **[S]** key to enter [parameter value]
  - e. In this area, press **[A][B][C][D]** key to make value adjustment.
  - f. Press **[S]** key to save the value.
- Note 1. After pressing **[S]** key, it will go back to [Normal Mode]  
 Note 2. Following example is for the Lockstitch machine.

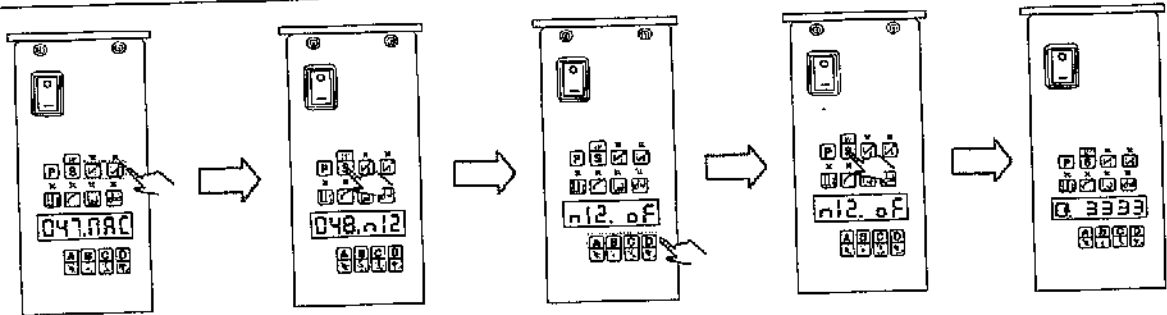

**(7).Key functions in the [Parameter Mode A and B] :** (example as the following)

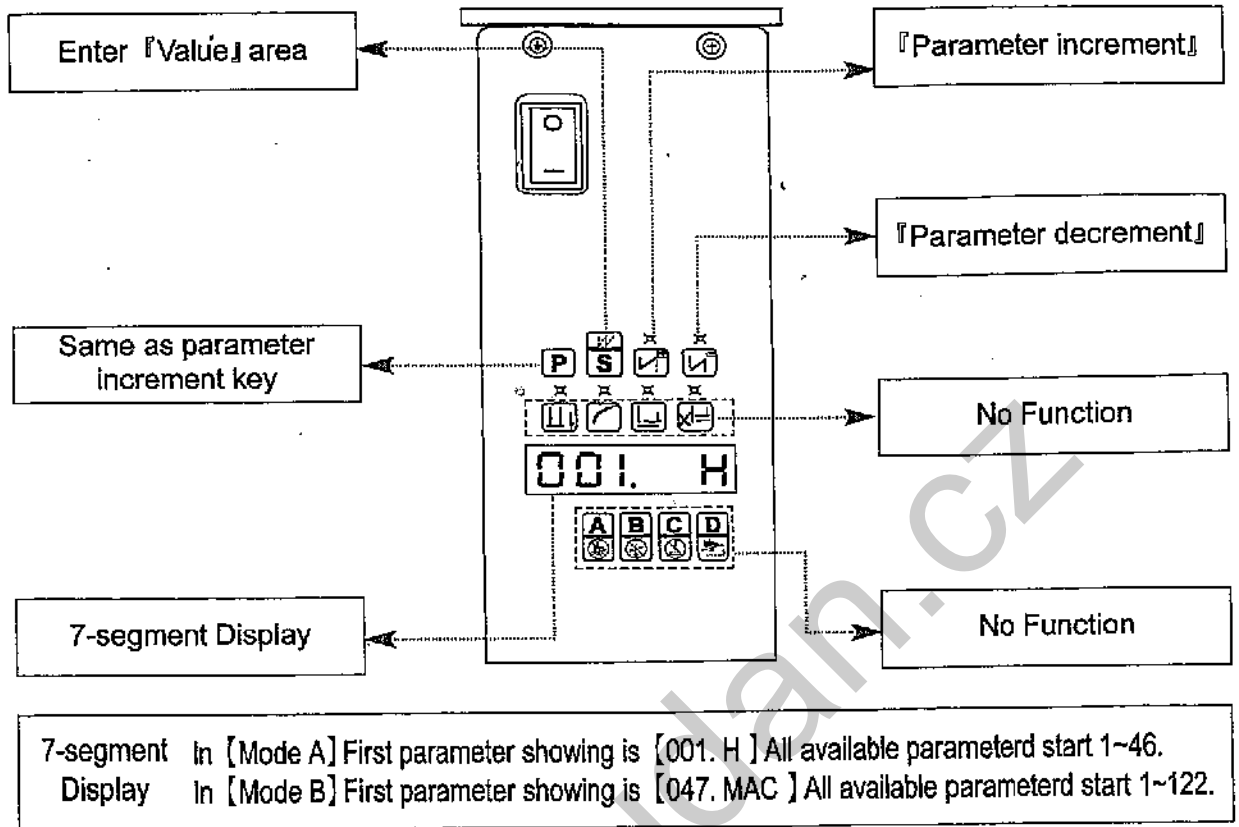

**(8). How to access the [Parameter Value] and adjust the setting**

- Step 1 : Confirm the parameter code you want to make adjust. ( see the parameter table for detail)
- Step 2 : Follow the instruction to access parameter area and call out the parameter code.
- Step 3 : Start adjusting the parameter value. (Function selection use key **C** and **D** to make change. Speed, timing and angle setting can be set as the following: [001. H] value setting for your reference)

**A). How to increase the default value :**

Example : Factory default setting [ H. 4500 ] increase to [ H. 5000 ]

See chapter 5, section (5) to learn how to access a,b,c value setting, then do the following step by step.

d. into [H.4500] value area

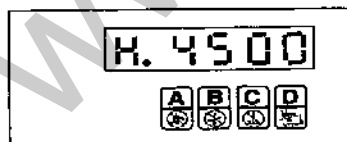

e. Press **B** to make increment

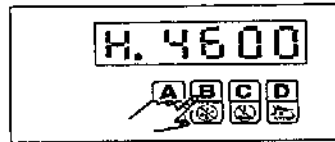

f. Stop until it shown at 5000

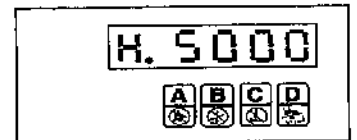

g. Use **S** to save the value



h. Go back to [Normal Mode]



※ [Normal mode] showing:  
 Example at left is showing for the Lockstitch machine. Interlock stitch machine icon showing is: [ ]



**B). How to decrease the default value:**

Example : Factory default setting [ H. 4500 ] decrease to [ H. 4000 ] :

See chapter 5, section ( 5 ) to learn how to access a - b - c value setting, then do the following step by step.

d. Into [ H.4500 ] value area

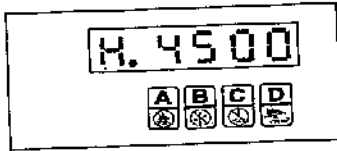

e. Press [ A ] to make decrement

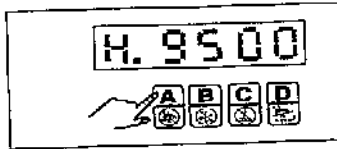

f. Stop when see minimum value

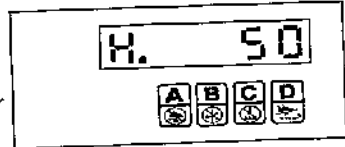

g. Use [ C ] to set the 10<sup>th</sup> digit

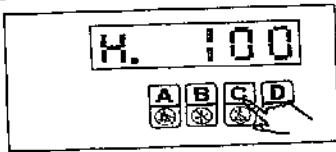

h. Use [ B ] to set 100<sup>th</sup> digit

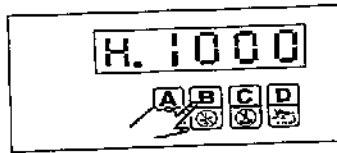

i. Use [ A ] to set 1000<sup>th</sup> digit

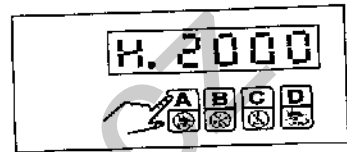

j. Stop at 4000 or any desire

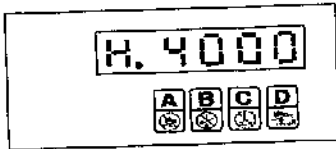

k. Use [ S ] to save the value

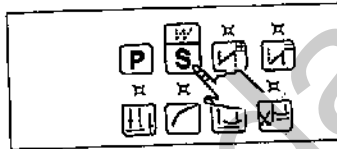

l. Go back to [ Normal Mode ]

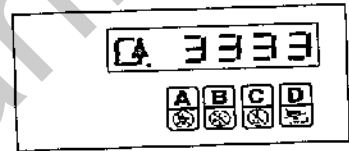

**(9). Terms and Value setting for A - B - C - D key in the [ Parameter Value ]**

Note 1: Digital scales in terms of sewing speed

TERMS \ KEY VALUE	A	B	C	D
IN TERMS OF SPEED	1000 spm	100 spm	10 spm	1 spm
IN TERMS OF ANGLE	-----	100°	10°	1°
IN TERMS OF TIMING	1000 ms	100 ms	10 ms	10 ms
IN TERMS OF FUNCTION			FUNCTION SWAP	FUNCTION SWAP

Other than the function selection, each press of the key will start change the value from 0 to 9

Note 2. After value changed, press key [ S ] to save the value, otherwise they will lost after turning power off.

## 6. General Parameter Table :

Parameter Code	Parameter Function	Range / Selection	Description / Note
001. H	Maximum sewing speed ( spm )	50~9999	Maximum speed adjustments.
004. N	Start Back-Tacking speed or Constant-Stitch speed for the Interlock Stitch machine ( spm )	50~8000	Speed adjustment for Start Back-Tacking or Constant-Stitch sewing in the Interlock Stitch machine.
005. V	End Back-Tacking speed ( spm )	50~8000	Speed adjustment for End Back-Tacking.
006. B	Bar-Tacking speed ( spm )	50~8000	Speed adjustment for Bar-Tacking
007. S	Slow Start speed ( spm )	50~2000	Speed adjustment for Slow Start.
008.SLS	Number of Stitches for the Slow Start	* 0~99	Number of Stitches setting for Slow Start.
009. A	Automatic Constant-Stitch sewing speed or Auto-start testing speed ( spm )	50~8000	Speed adjustment for Automatic Constant-Stitch sewing. Note: Valid only when the [ 037. SMP ] set on [ A ]
010.ACD	Automatic End Back-Tacking sewing (Can invalidate the Stitch Correction function)	ON / OFF	ON : After last seam of Constant-Stitch sewing, it will automatic execute the End Back-Tacking sewing function. Note: When turned on, the Stitch-Correction is invalid. OFF : Automatic End Back-Tacking will not execute after last seam, but can be done by pedal manually Note: The Stitch-Correction is valid in Free sewing, but the parameter [011.RVM] must set on [ B ]
011.RVM	Back-Tacking Mode selection	J / B	J : JUKI mode ( Press TB switch will activate the reverse solenoid when either machine is stopped or running). B : BROTHER mode (Press TB switch will activate the reverse solenoid only when machine is running).
040.WON	Wiper function selection	ON / OFF	ON : Wiper valid. OFF: Wiper invalid.
041. TM	Trimmer function selection	ON / OFF	ON : Trimmer valid. OFF : Trimmer invalid.
045. SP	Sewing speed		Showing the current sewing speed.
046.DIR	Direction of motor rotation	CW / CCW	CW : Clockwise. CCW : Counterclockwise.
060. L	Low speed ( spm )	50~500	Speed adjustment for Low speed.
061. T	Trimmer speed ( spm )	50~500	Speed adjustment for Trimmer.
064. FO	Full-On time setting for A.F.L. (ms)	0~990	Timing adjustment for Full-On time of Automatic Foot Lifter activates.
065. FC	Duty-Cycle setting for A.F.L. (%)	0~90	Adjustment for Duty-Cycle of AFL.(Fine tuning can reduce the over heating)
066. FD	Running-Delay time setting (ms)	0~990	Running-Delay time adjustment for the Automatic Foot Lifter.
070.HHC	Cancel Automatic Foot Lifting when Half-Heeling the pedal	ON / OFF	ON : Pedal half heeling without foot lifting function. (Only full heeling can activate Foot Lifter.) OFF: Pedal half heeling with foot lifting function.
075.SFM	Safety switch mode	NC / NO	NO : Means Normal Opened. NC : Means Normal Closed.
083. T2	Trimming timing (ms)	0~990	Adjustment for trimming timing
087. L2	Tension release timing (ms)	0~1500	Adjustment for tension release timing. (In Shing Ray brand's interlock stitch machine, it acts as wiper function.)
093. W2	Wiper timing (ms)	0~9990	Adjustment for wiper timing.
119. DD	Motor drive mode	ON / OFF	ON : Motor drive machine head directly OFF : Motor drive machine head with belt.
121.ANU	Needle goes up automatically as power turned on	ON / OFF	ON : Power turned on, needle goes up position automatically. OFF : No Use.

## 7. Basic Troubleshooting :

### (1). Error Code and Measurement :

Error Code	Cause of The Problem	Status and Measurement
ER0. 4	<ol style="list-style-type: none"> <li>1. When power on, detected high voltage</li> <li>2. Connect the wrong voltage, too high.</li> <li>3. Aluminum casing resistor for the brake circuit is defective or main board F2 fuse burst.</li> </ol>	<p>Motor and machine will be shutting down. Please check the AC power. (Too high)</p> <p>*If control box is AC 220V system, don't use the AC 380V power voltage, otherwise the LED will display ER0. 4 after 2 second of power ON. If continue supply the 380V power, the electrolytic capacitors (C7,C8,C9) of main board will burst open over a period of time and cause the fuses (F3,F4) of power input open circuit.</p> <p>Please check the main board. Please check the aluminum casing resistor and main board F2 fuse.</p>
ER0. 5	<ol style="list-style-type: none"> <li>1. When power on, detect low voltage</li> <li>2. Connect the wrong voltage, too low.</li> </ol>	<p>Motor and machine will be shutting down.. Please check the AC power. (Too low) Please check the main board.</p>
ER0. 7	<ol style="list-style-type: none"> <li>1. Bad connection at the motor connector.</li> <li>2. Synchronizer (sensor) signal error.</li> <li>3. Synchronizer is a single position type, and parameter set wrong type.</li> <li>4. Machine locked or object stuck in the motor pulley.</li> <li>5. Sewing material is too thick.</li> </ol>	<p>Motor and machine will be shutting down.</p> <p>Please check the motor or motor connectors connection. Please check the Synchronizer (sensor) and its signal. Please check machine head to see if objects stuck in the motor pulley, or rotate not smoothly.</p>
ER0. 8	Operation Box linked to CPU interface had communication error	<p>Motor and machine will be shutting down. Please check the Operation Box.</p>
ER0. 9	<ol style="list-style-type: none"> <li>1. Machine solenoid shorted.</li> <li>2. Main board's power transistor is faulty.</li> </ol>	<p>Motor still can run, but all output signals and Operation box's pattern sewing function will be invalid. Please check machine's solenoids or the resistance value is 2 Ω less. Please check all the power transistors which related to solenoid.</p>
ER0. 11	<ol style="list-style-type: none"> <li>1. If parameter [121.ANU] is set ON, but Auto Needle Up is malfunction when the power turned on.</li> <li>2. Machine locked or motor pulley have object stuck in it.</li> </ol>	<p>Motor and machine will be shutting down. Please check Synchronizer's up position's signal. Please check main board's Synchronizer circuitry. Please check machine head to see if objects stuck in motor pulley, or rotate not smoothly.</p>
ER0. 12	<p>Motor rotation icon in LED is halting and not moving.</p> <ol style="list-style-type: none"> <li>1. Safety switch is either faulty or bad connection. (For interlock stitch or blind stitch machine).</li> <li>2. Parameter [075.SFM] setting not match the machine head model.</li> </ol>	<p>Motor stops. Please check the safety switch. Please check parameter table on [075.SFM] setting, make sure it match machine head safety switch</p>

## (2). Instruction of Fuse Replacement:

Fuse Type and Location: When fuse fused, find out the cause and fix it before replace the new one.

Main Board Top View

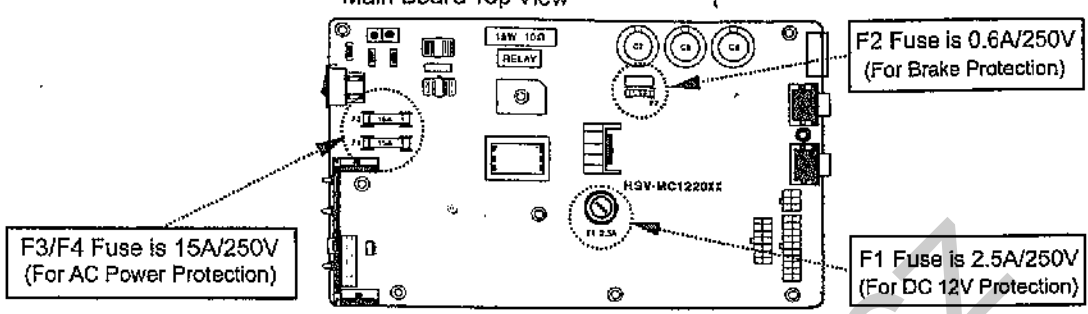

F2 Fuse is 0.6A/250V  
(For Brake Protection)

F3/F4 Fuse is 15A/250V  
(For AC Power Protection)

F1 Fuse is 2.5A/250V  
(For DC 12V Protection)

 CAUTION: Turn off the power and wait 10 minutes before opening box cover.

## (3). Others:

1.If motor install with the machine head, then the CN2 must be shorted.  
The error code 12 will occur if CN2 not shorted.

Main board layout

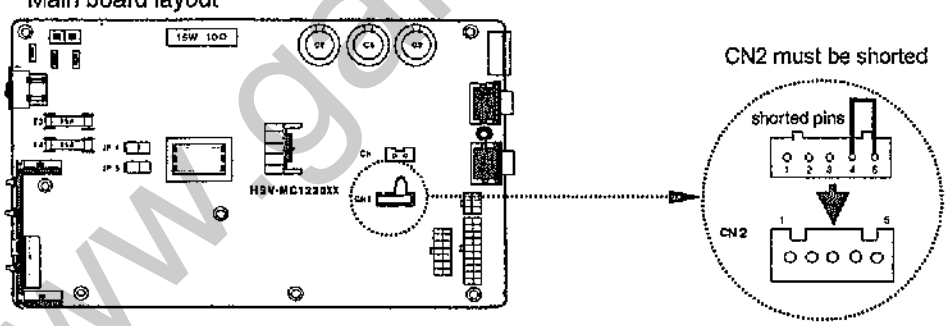

CN2 must be shorted

 CAUTION: Turn off the power and wait 10 minutes before opening box cover.

2.During the machine's operation, if the synchronizer (sensor) felt out or the belt snapped. The motor will rotate few stitches then stop, and ER0.7 will be shown in the display. Turn off the power and troubleshooting first then restart the power.

3.If other technical issues occur, beside the fuse replacement, don't try to change any parts in the control box. Please ask supplier or trained technician for technical support.

### (4).HVP-70 Parts List :

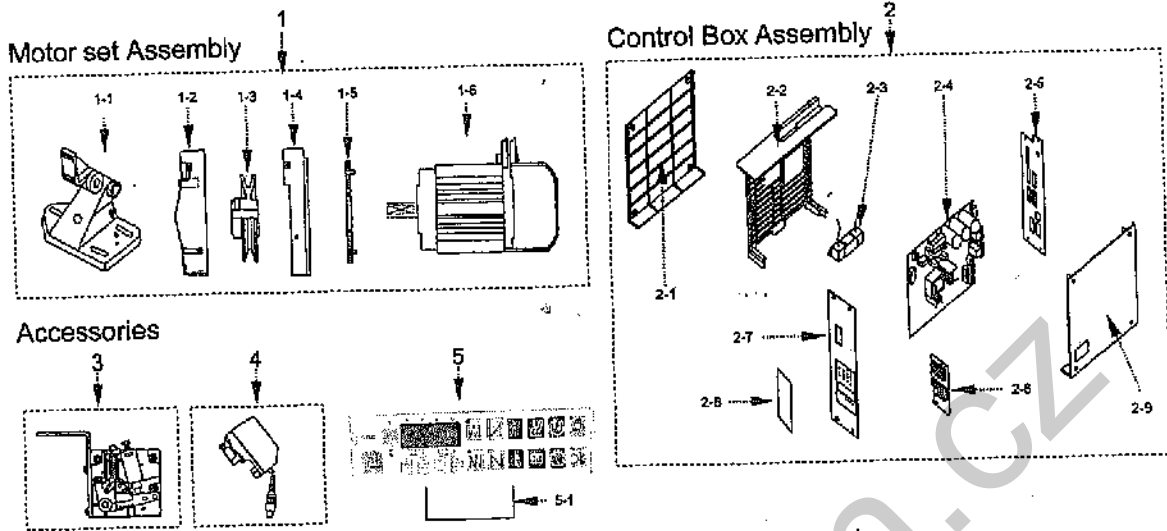

NO.	Order Code	Parts Name	Description
1	2VP3411209AX1	Motor Set (CE)	Ke: 37 75EC006
	2VP3411209AX2	Motor Set	Ke: 37 75EC006
	2VP3411209AX3	Motor Set (CE)	Ke: 50 75CC006
	2VP3411209AX4	Motor Set	Ke: 50 75CC006
	2VP3432209AX3	Motor Set	Ke: 28 50AB007
	2VP3432209AX4	Motor Set (CE)	Ke: 28 50AB007
1-1	2VPBTV020	Motor Base	For HVP-70
1-2	315BGV080	Belt Cover Top	For V-Belt Type
1-3	2VP2PY4041D	Pulley (65mm)	(14 φ hole)
	2VP2PY4061D	Pulley (75mm)	(14 φ hole)
1-3	2VP2PY4081D	Pulley (85mm)	(14 φ hole)
1-4	315BGV070	Belt Cover Base	For V-Belt Type
1-5	313BGE030	Cover Bracket	For V-Belt Type
1-6	2VP3411209AX6	Motor Body (CE)	750W Ke : 37
	2VP3411209AX7	Motor Body	750W Ke : 37
	2VP3411209AX8	Motor Body (CE)	750W Ke : 50
	2VP3411209AX9	Motor Body	750W Ke : 50
	2VP3432209AX8	Motor Body	500W Ke : 28
	2VP3432209AX9	Motor Body (CE)	500W Ke : 28
2	2VP70400BR101	HVP-70-4-BR-1	100 ~ 120V
1	2VP70400BR201	HVP-70-4-BR-2	200 ~ 240V
1	2VP704007W201	HVP-70-4-7W-2	200 ~ 240V
1	2VP70400GD201	HVP-70-4-GD-2	200 ~ 240V

NO.	Order Code	Parts Name	Description
2-1	315MPB270	Left Cover	Cover (no screw)
	331SP1130	Left Cover Screws	M4x8
2-2	2VPMPB205	Aluminum Case	HVP-70 Series
2-3	2VP70304201	Cement Resistor	220 Ω / 30W
2-4	2VP70302005	Main Board	1 φ 20A
2-5	2VP70408BR001	Connector Panel	HVP-4-BR
	2VP704087W001	Connector Panel	HVP-4-7W
	2VP70308H1001	Connector Panel	HVP-3-H1
	2VP7040866001	Connector Panel	HVP-4-66
	2VP7040846001	Connector Panel	HVP-4-46
	2VP7040870001	Connector Panel	HVP-4-70
	2VP7040898001	Connector Panel	HVP-4-98
	2VP70408GD001	Connector Panel	HVP-4-GD
2-6	2VPPCB181	LED Panel Board	7mm tack switch
2-7	315MPB290	Control Panel	For 1 φ
2-8	341V50103	Membrane Sticker	For HVP-70
2-9	315MPB280	Right Cover	Cover (no screw)
	331SP1860	Right Cover Screws	M4x0.7x25
3	2VP70306001	Speed Control Unit	With bracket
4	2VP115002900	Synchronizer	500-29 (8P)
5	2VPOPBC30001	Operation Box	C-300 1.0m.
	2VPOPBC30002	Operation Box	C-300 1.5m.
5-1	2VPOPBPT03	Curve Bracket	For C-300





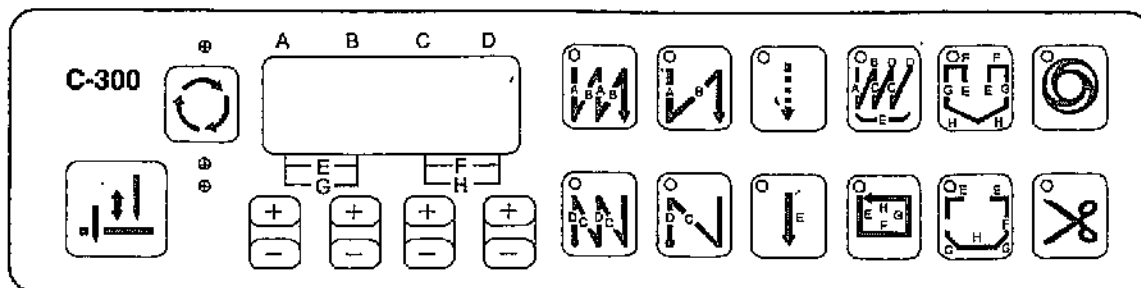



## 8. Operation Box :

### (1). C-300 Operation Box Diagram



### (2). Key functions of C-300

FUNCTION	KEY	OPERATION OF SEWING MACHINE
Start Back Tacking Selection		Double start back tacking
		Single start back tacking
End Back Tacking Selection		Double end back tacking
		Single end back tacking
Free Sewing		<ol style="list-style-type: none"> <li>1). As the treadle is toed down, machine will start sewing. Once the treadle returned to neutral, machine will stop immediately.</li> <li>2). As the treadle heeled back, the trimming cycle will be finished automatically.</li> </ol>
Bar Tack Sewing		<p>Once the treadle is toed down, all the seams of Bar Tacking, A,B,C,D sections will be completed with E times, and the trimming cycle will be finished automatically</p> <p>Note1: When E is 4 times above, then the exceeded times will be started by the C - D section.</p> <p>Note2: When the bar tack sewing start, it will not stop until the trimming cycle finished, except for the treadle heeled back to cancel the action.</p>
Constant-Stitch Sewing	 or  or  or 	<ol style="list-style-type: none"> <li>1). As the treadle is toed down, Constant-stitch Sewing E,F,G or H performed section by section.</li> <li>2). Once the treadle returns to neutral intermediately in any one section, the machine will stop immediately. When the treadle toed down again the balanced stitches of E,F,G or H goes on.</li> <li>3). If the parameter [010. ACD] is set ON, the machine will not stop and automatically start trimming cycle and end back tacking at the end of the last section E or H.</li> </ol>

<p>Stitch Setting Selection</p> 		<p>A \ B \ C \ D -- stitch setting range in 0 ~ F (Note)  E \ F \ G \ H -- stitch setting range in 0 ~ 99</p> <div style="display: flex; align-items: center; margin-bottom: 10px;">  <div style="margin-left: 10px;"> <table border="1" style="border-collapse: collapse; text-align: center;"> <tr><td>A</td><td>B</td><td>C</td><td>D</td></tr> <tr><td>4</td><td>4</td><td>4</td><td>4</td></tr> </table> </div> <div style="margin-left: 20px;"> <p>... A=B=C=D=4 stitches</p> </div> </div> <div style="display: flex; align-items: center; margin-bottom: 10px;">  <div style="margin-left: 10px;"> <table border="1" style="border-collapse: collapse; text-align: center;"> <tr><td>A</td><td>B</td><td>C</td><td>D</td></tr> <tr><td>1</td><td>0</td><td>1</td><td>0</td></tr> </table> </div> <div style="margin-left: 20px;"> <p>... E=F=10 stitches</p> </div> </div> <div style="display: flex; align-items: center;">  <div style="margin-left: 10px;"> <table border="1" style="border-collapse: collapse; text-align: center;"> <tr><td>A</td><td>B</td><td>C</td><td>D</td></tr> <tr><td>1</td><td>5</td><td>1</td><td>5</td></tr> </table> </div> <div style="margin-left: 20px;"> <p>... G=H=15 stitches</p> </div> </div> <p>∴ Press  key to select : Top A \ B \ C \ D  Middle E \ F  Bottom G \ H</p>	A	B	C	D	4	4	4	4	A	B	C	D	1	0	1	0	A	B	C	D	1	5	1	5
A	B	C	D																							
4	4	4	4																							
A	B	C	D																							
1	0	1	0																							
A	B	C	D																							
1	5	1	5																							
<p>Needle Up / Forward Stitch Correction</p> 		<p>1). In Free sewing:  One touch of this key act as stitch correction. (half stitch forward)</p> <p>2). In constant-stitch sewing :  ( In Bar-tack sewing, it only act as needle up )  a. If sewing stops intermediately in one section, one touch of this key will raise the needle to up position.  b. If sewing stops at the end of section, one touch of this key will correct one stitch forward.</p>																								
<p>One-Shot-Sewing Selection</p> 		<p>1). In Free sewing and Bar-tack sewing:  One touch of this key make beep sound but have no function, also LED does not light up,.</p> <p>2). In Constant-stitch sewing:  a. One shot to the pedal, automatic performed number of stitches of E \ F \ G \ H sections.  b. Toe down the pedal again and again to finish rest the sections until it finish pattern</p>																								
<p>Trimming Cycle Selection</p> 		<p>Enable or disable the trimming cycle.</p>																								

Note : Stitches setting of A \ B \ C \ D sections correspond to the alphabet.  
A=10 \ B=11 \ C=12 \ D=13 \ E=14 \ F=15 stitches

# 9. CONNECTOR DIAGRAM :

## (1). HVP-70-3/4-BR : (T1)

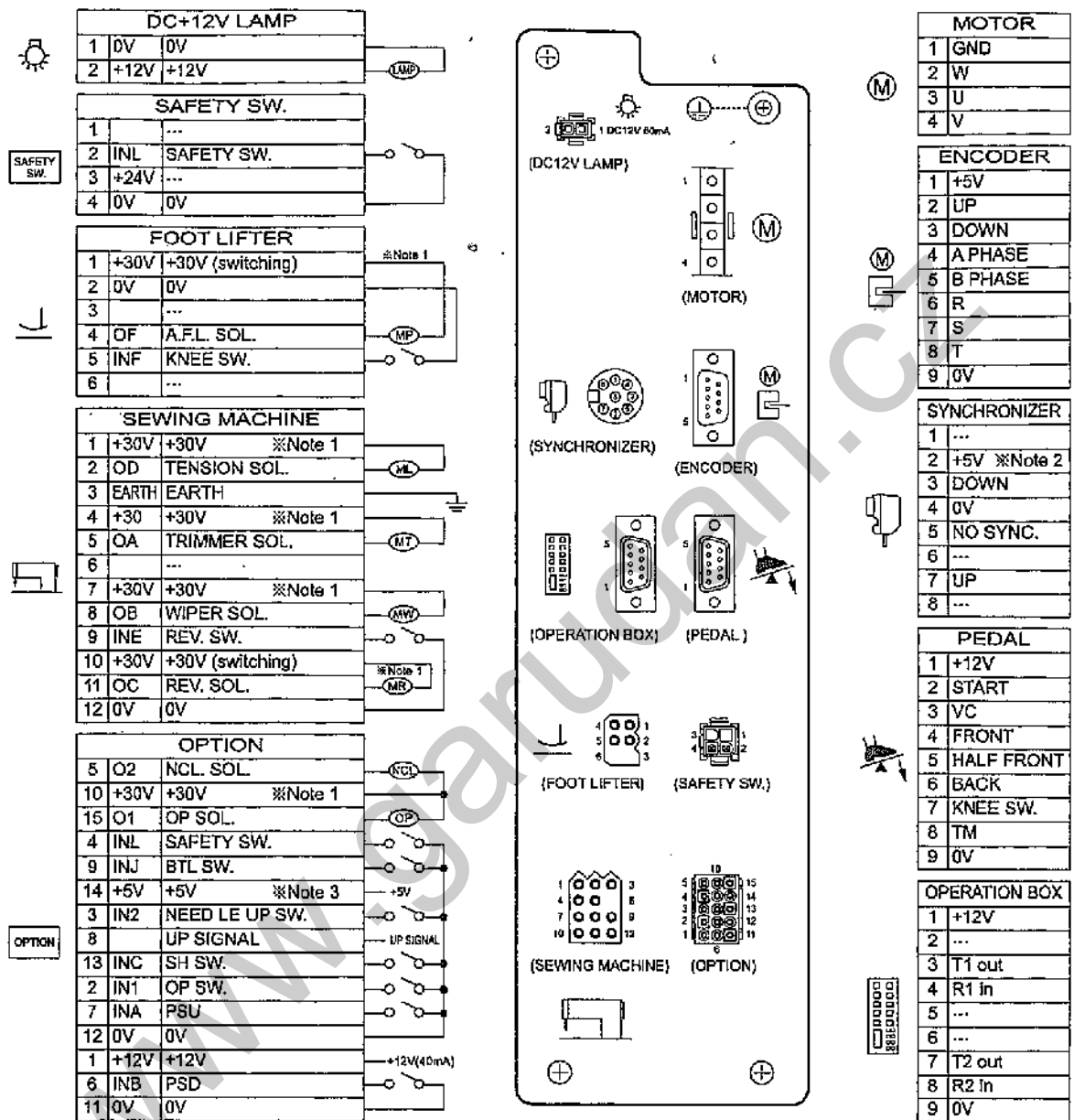

NOTE : For HVP-70-3-BR, There is no [ OPTION ]

Item	Voltage supply	Factory setting	Location	Description
Note 1	30V / 24V	30V	JP4 / JP5	JP4=30V , JP5=24V
Note 2	12V / 5V	5V	JP3	must be set at 5V
Note 3	12V / 5V	5V	JP10	
<b>Remark</b>	Switching voltage output is available for MR,MP only.			



## (2). HVP-70-3/4-7W :

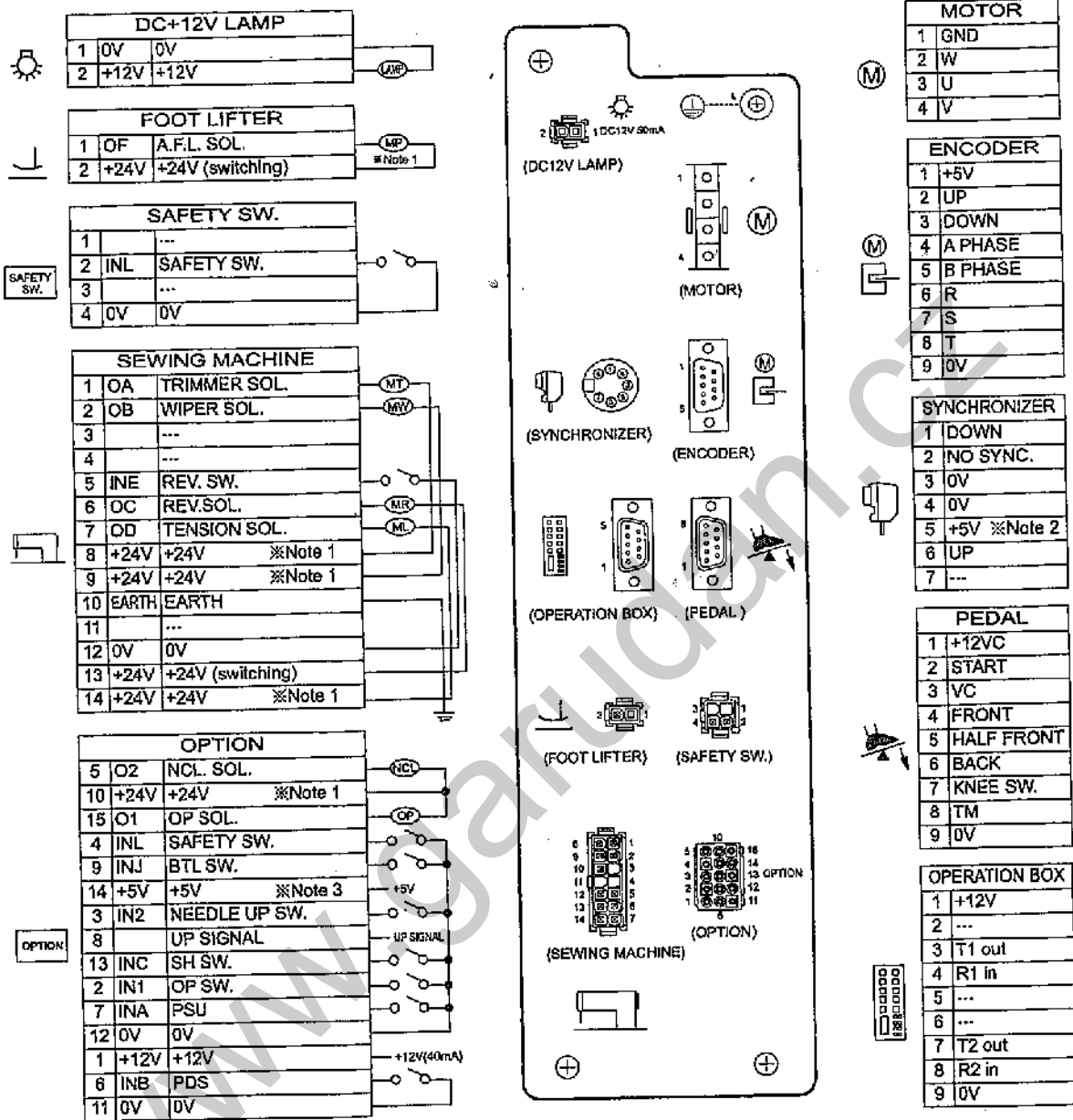

NOTE : For HVP-70-3-7W, There is no [ OPTION ]

Item	Voltage supply	Factory setting	Location	Description
Note 1	30V / 24V	24V	JP4 / JP5	JP4=30V , JP5=24V
Note 2	12V / 5V	5V	JP3	must be set at 5V
Note 3	12V / 5V	5V	JP10	
Remark	Switching voltage output is available for MR,MP only.			

### (3). HVP-70-3/4-H1 : (H2) (H3)

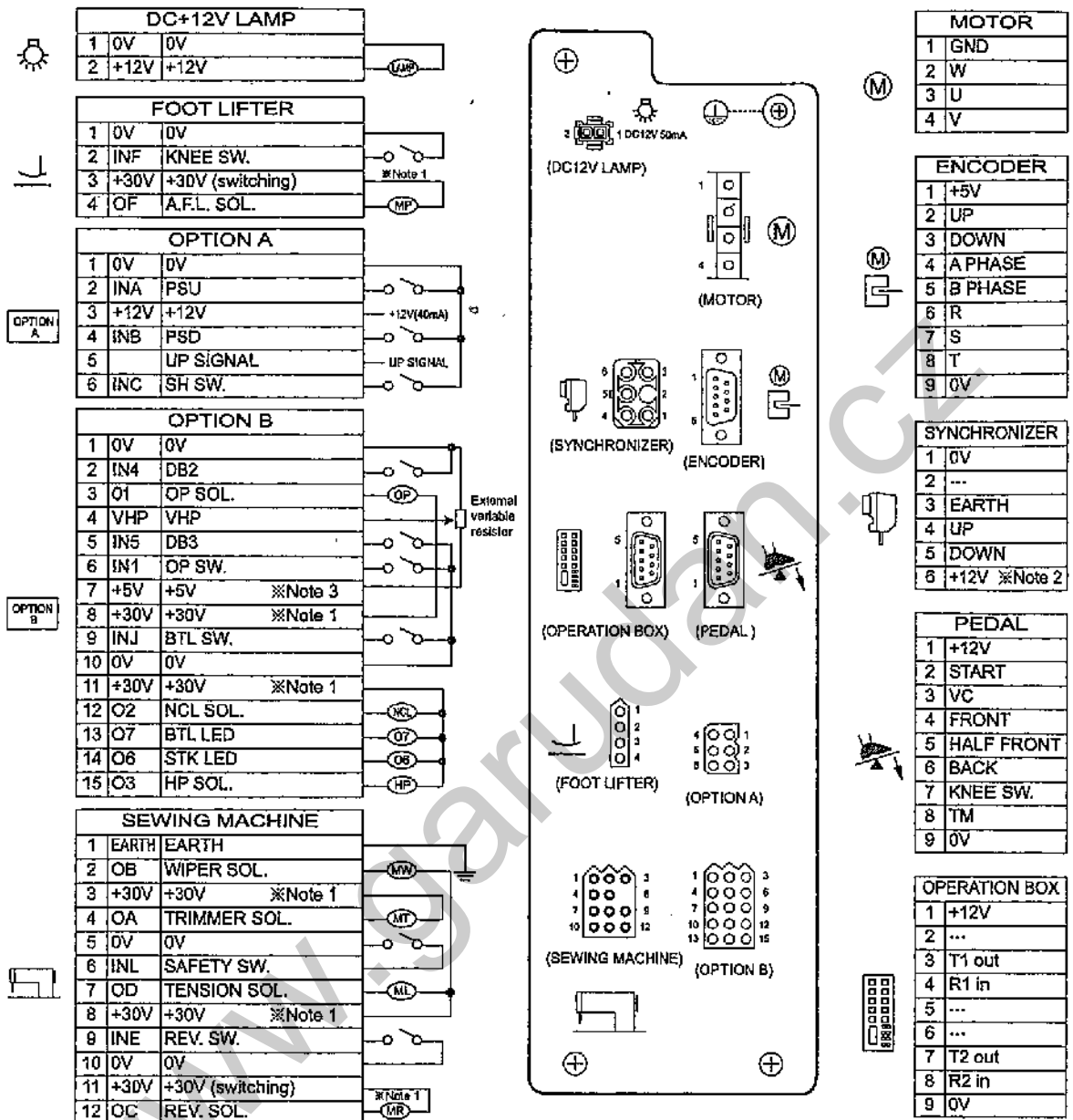

NOTE : For HVP-70-3-H1, There is no [ OPTION A & OPTION B ]

Item	Voltage supply	Factory setting	Location	Description
Note 1	30V / 24V	30V	JP4 / JP5	JP4=30V · JP5=24V
Note 2	12V / 5V	12V	JP3	must be set at 12V
Note 3	12V / 5V	5V	JP10	
Remark	Switching voltage output is available for MR,MP only.			

### (4). HVP-70-4-66 : (V7)

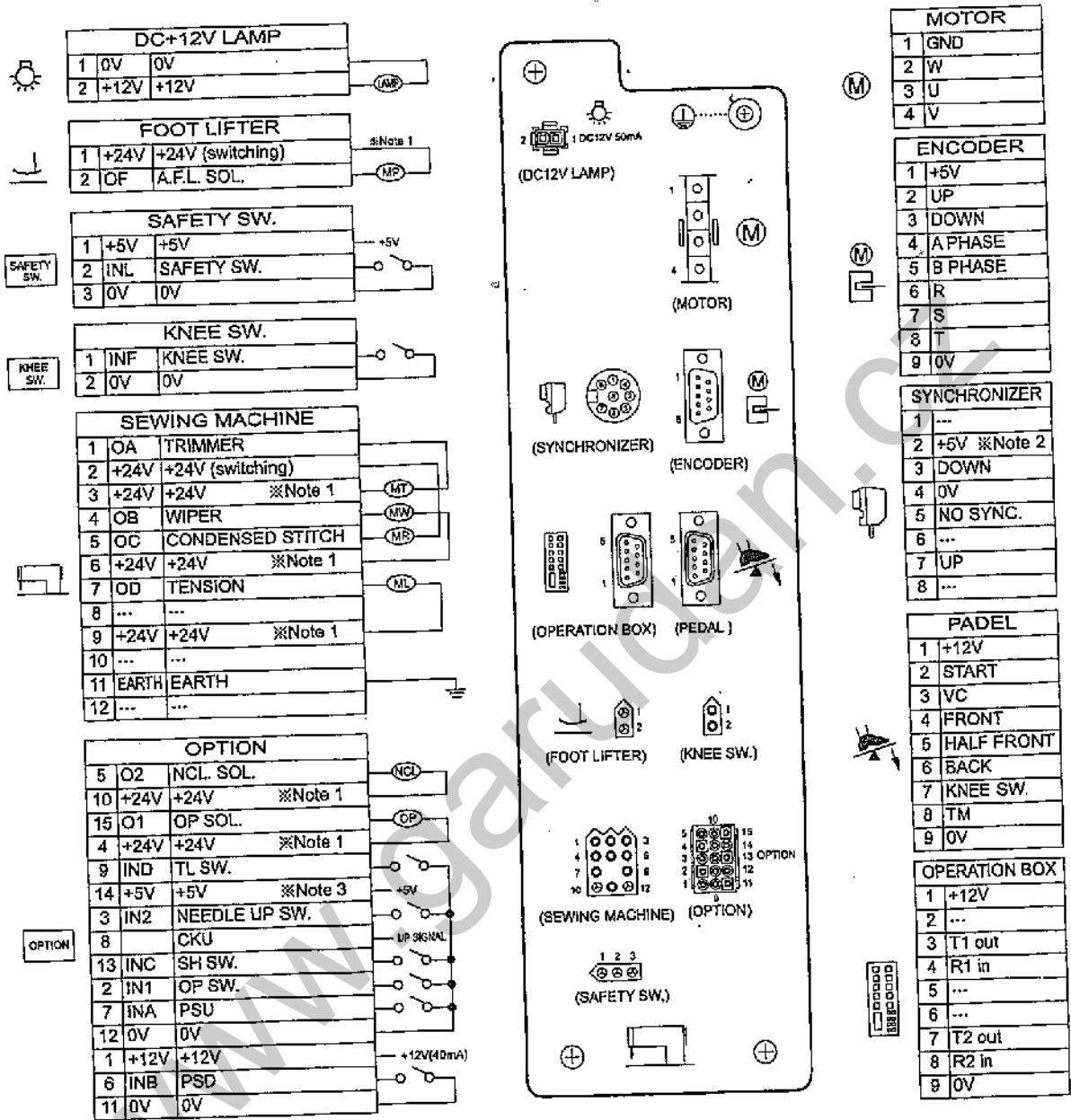

**NOTE :**

Item	Voltage supply	Factory setting	Location	Description
Note 1	30V / 24V	24V	JP4 / JP5	JP4=30V , JP5=24V
Note 2	12V / 5V	5V	JP3	must be set at 5V
Note 3	12V / 5V	5V	JP10	
<b>Remark</b>	Switching voltage output is available for MR,MP only.			

### (5). HVP-70-4-46 : (T2)

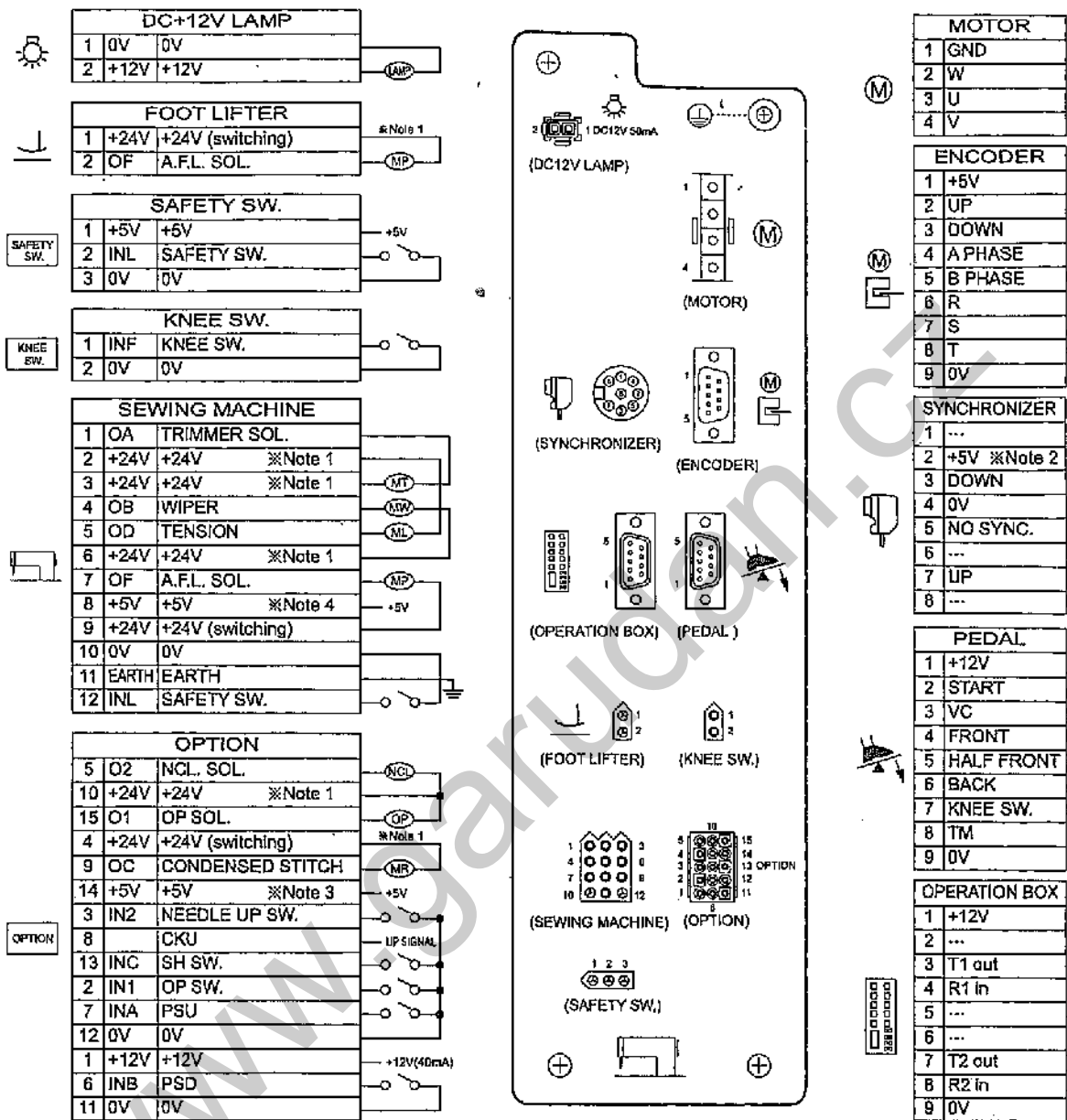

NOTE :

Item	Voltage supply	Factory setting	Location	Description
Note 1	30V / 24V	24V	JP4 / JP5	JP4=30V , JP5=24V
Note 2	12V / 5V	5V	JP3	must be set at 5V
Note 3	12V / 5V	5V	JP10	
Note 4	12V / 5V	5V	JP11	
<b>Remark</b>	Switching voltage output is available for MR,MP only.			

**(6). HVP-70-4-70 :**

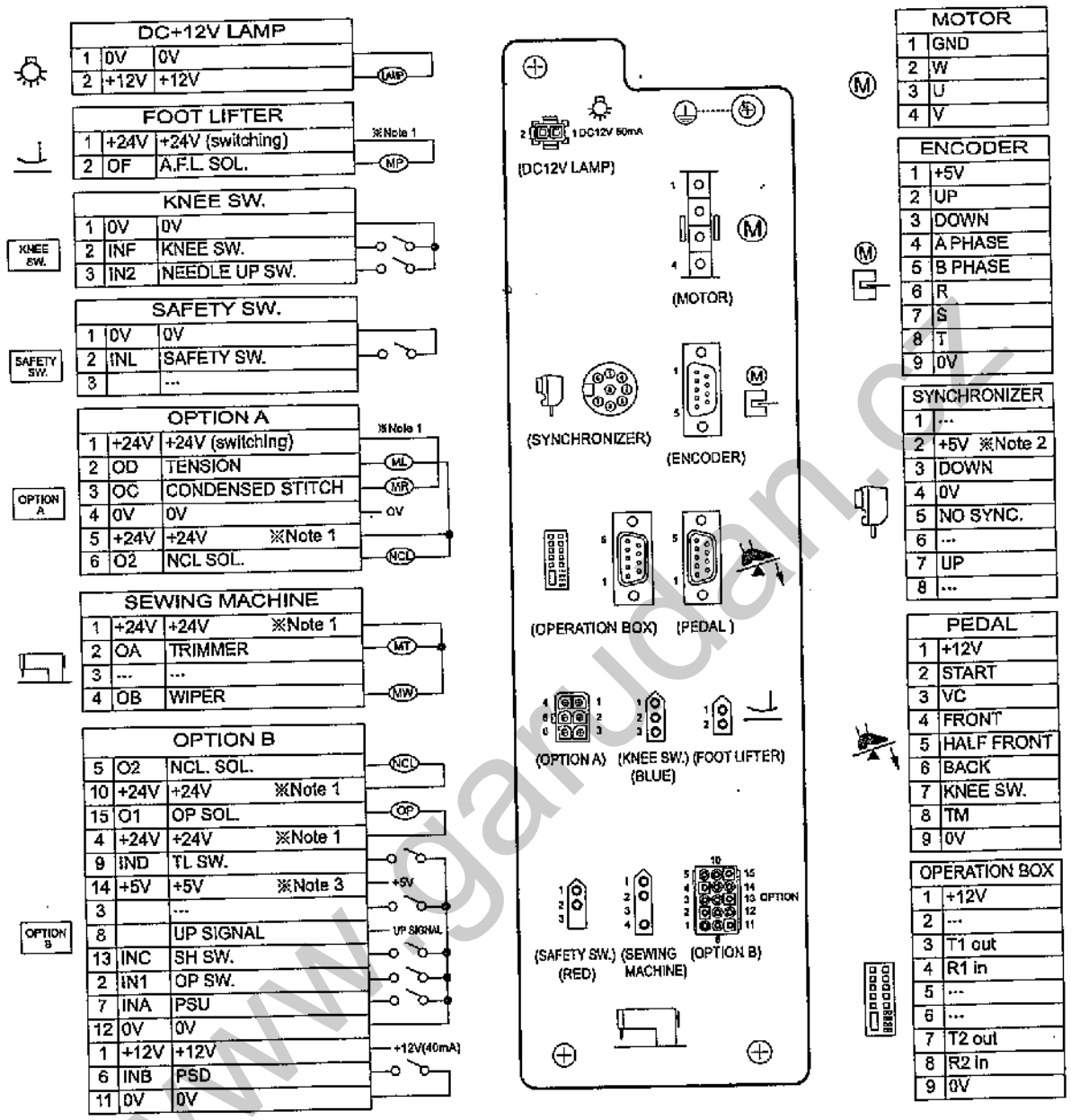

**NOTE :**

Item	Voltage supply	Factory setting	Location	Description
Note 1	30V / 24V	24V	JP4 / JP5	JP4=30V , JP5=24V
Note 2	12V / 5V	5V	JP3	must be set at 5V
Note 3	12V / 5V	5V	JP10	
<b>Remark</b>	Switching voltage output is available for MR,MP only.			

## (7). HVP-70-4-98 :

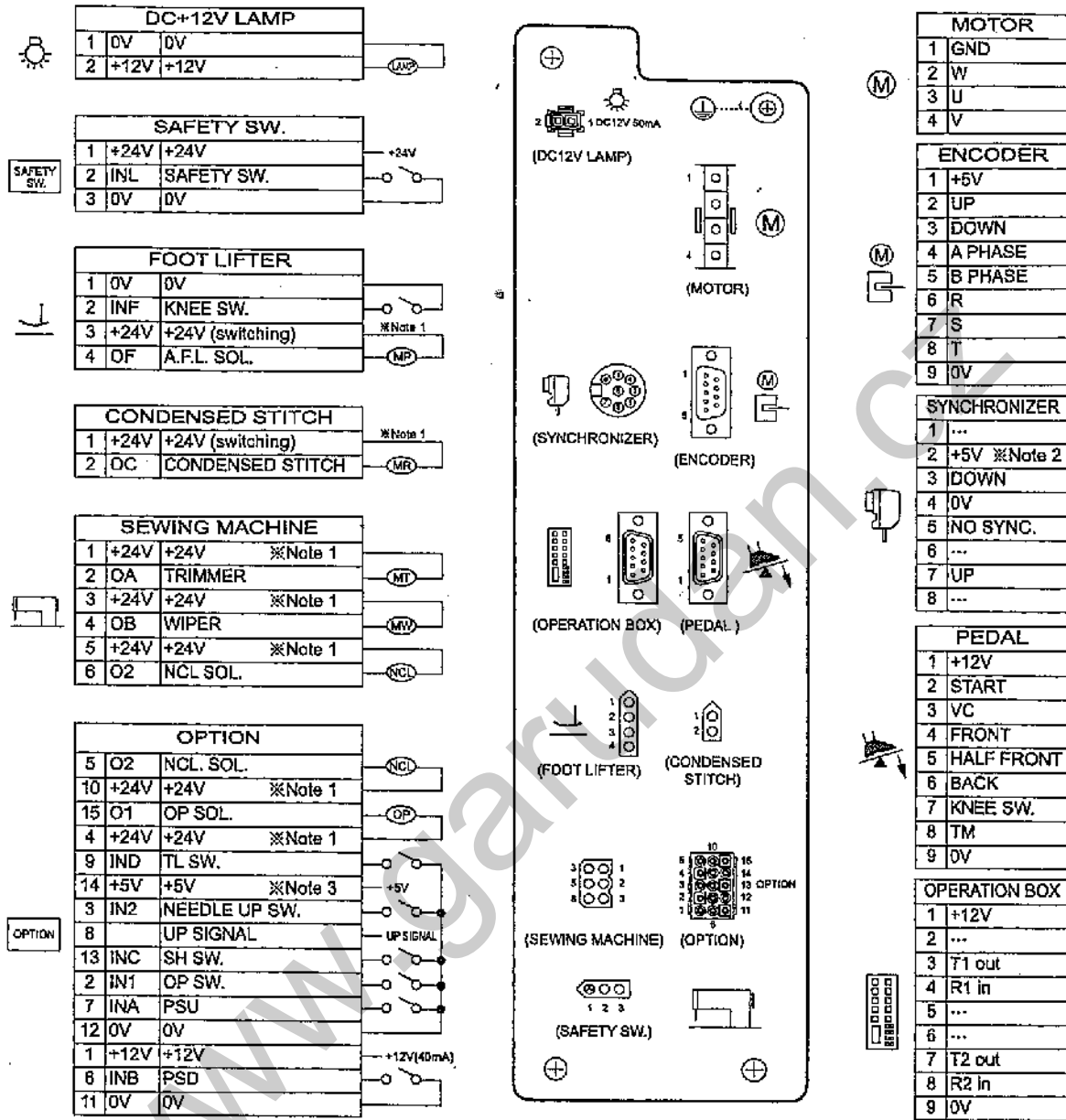

NOTE :

Item	Voltage supply	Factory setting	Location	Description
Note 1	30V / 24V	24V	JP4 / JP5	JP4=30V · JP5=24V
Note 2	12V / 5V	5V	JP3	must be set at 5V
Note 3	12V / 5V	5V	JP10	
<b>Remark</b>	Switching voltage output is available for MR,MP only.			

### (8). HVP-70-4-GD :

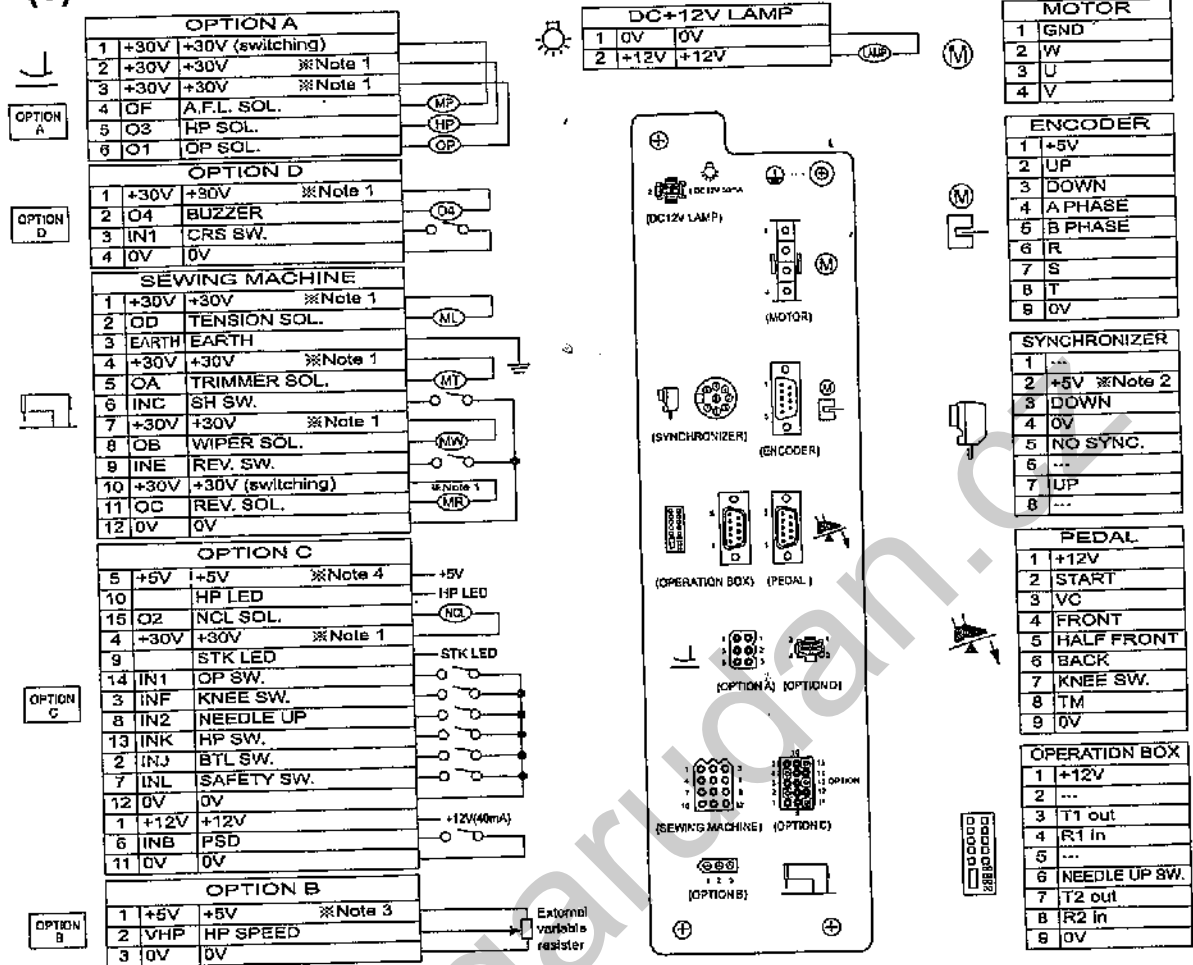

**NOTE :**









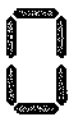

Item	Voltage supply	Factory setting	Location	Description
Note 1	30V / 24V	30V	JP4 / JP5	JP4=30V , JP5=24V
Note 2	12V / 5V	5V	JP3	Must be set at 5V
Note 3	12V / 5V	5V	JP10	Setting at 6V for Gerudan machine
Note 4	12V / 5V	5V	JP11	
<b>Remark</b>	Switching voltage output is available for MR,MP only.			

MACHINE CODE DESCRIPTION		
GROUP	CODE	MACHINE
GARUDAN	88	GARUDAN GF-115 (built-in synchronizer.)
	89	GARUDAN GF-115 (external synchronizer.)
	90	GARUDAN GF-115-447 (built-in synchronizer.)
	91	GARUDAN GF-115-447 (external synchronizer.)
	92	GARUDAN GF-130-446H (built-in synchronizer.)
	93	GARUDAN GF-130-446 H (external synchronizer.)
	94	GARUDAN GF-130-446 LM (external synchronizer.)
	95	GARUDAN GF-207 Series
	96	GARUDAN GF-238-448 / GF-133-448 Series
	97	GARUDAN GP-510-146
	98	GARUDAN GP-510-446
	99	GARUDAN CT / FT Series
	100	GARUDAN GF-138 / -238 Series
	101	GARUDAN GZ-500 Series





















七段顯示器字體與實際數值對照表：

7-Segment Display Characters Compare Table :

數值字體部份 : (Arabic Numerals)

實際數值 (Actual)	0	1	2	3	4	5	6	7	8	9
顯示字體 (Display)										

英文字體部份 : (English Alphabet)

實際字母 (Actual)	A	B	C	D	E	F	G	H	I	J
顯示字體 (Display)										
實際字母 (Actual)	K	L	M	N	O	P	Q	R	S	T
顯示字體 (Display)										
實際字母 (Actual)	U	V	W	X	Y	Z				
顯示字體 (Display)	